



Greenwood[®]

your eden **2019**



Da oltre mezzo secolo siamo protagonisti di primo piano nei settori degli ombrelli ed ombrelloni, mobili per esterni, complementi d'arredo e forniture per pubblici esercizi (Contract). Nel tempo le nostre risorse produttive sono state costantemente aggiornate con l'obiettivo di fornire alla clientela risposte puntuali ad esigenze in continua evoluzione. Le nostre scelte sono sempre coerenti con le tendenze del gusto e con il mutare degli stili di vita: all'interno dei nostri cataloghi ritroverete sempre prodotti orientati ad un gusto classico accanto a proposte innovative e di tendenza. Tutti i prodotti Moia sono caratterizzati da una grande attenzione alla qualità delle materie prime, delle lavorazioni e delle finiture. Il nostro primo obiettivo è la soddisfazione del Cliente, per questo siamo molto attenti agli aspetti organizzativi ed al servizio. La nostra Organizzazione Vendite è costantemente a disposizione per fornire, oltre ai prodotti, un vero e proprio supporto informativo e di consulenza.





moia 

INDICE

Ombrelloni di piccole dimensioni	pag. 5
Ombrelloni	pag. 17
Gazebo	pag. 43
Dondoli	pag. 75
Cover	pag. 79
Mobili in legno di acacia	pag. 81
Acacia anticata	pag. 87
Mobili in legno di teak	pag. 91
Mobili maxi in teak	pag. 99
Mobili in teak e alluminio	pag. 103
Mobili in resin wood	pag. 111
Mobili in ferro	pag. 117
Mobili in ferro colorato	pag. 145
Mobili in alluminio	pag. 151
Balcony Set	pag. 177
Mobili in alluminio con corda	pag. 183
Salotti in metallo	pag. 195
Mobili in wicker	pag. 213
Mobili in fibra naturale	pag. 243
Mobili in legno	pag. 251
Panche	pag. 253
Mobili in bambù	pag. 255
Spiaggine, sdraio, lettini e articoli da giardino	pag. 257
Amache	pag. 271



Greenwood[®]



OMBRELLONI DI PICCOLE DIMENSIONI

Fantasie rigate, tinte unite sgargianti e attenzione ai dettagli per la collezione di ombrelloni Greenwood. Non mancano le proposte di prodotto nazionale, realizzato interamente da chi, da 60 anni, realizza ombrelloni con fusti e tessuti d'eccellenza.



B 926 IESOLO

Misura: 200/8
Bacchette: 3,2 mm
Fusto: Ø 33 mm
con bloccaggio e snodo
Colori: fantasie e rigato
Materiale: cotone 150 gr
Imballo: 10 pz

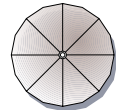

Ø 200 - 8 teli



E 587 POLIESTERE UNITO

Misura: 200/8
Bacchette: 3,8 mm
Fusto: Ø 33 mm
con bloccaggio e snodo
Colori: tinte unite
Materiale: poliestere 150 gr
Imballo: 10 pz

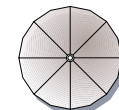

Ø 200 - 8 teli



B 935 COTONE ECRÙ

Misura: 200/8
Bacchette: 3,8 mm
Fusto: Ø 33 mm
con bloccaggio e snodo
Colori: tinta unita ecrù
Materiale: cotone 220 gr
Imballo: 10 pz

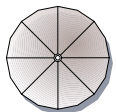

Ø 200 - 8 teli

B 988 COTONE ECRÙ

Misura: 240/10
Bacchette: 3,8 mm
Fusto: Ø 33 mm
con bloccaggio e snodo
Colori: tinta unita ecrù
Materiale: cotone 220 gr
Imballo: 5 pz
Fusto disponibile nei colori:
verde, bianco

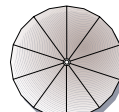

Ø 240 - 10 teli



E 592 POLIESTERE

Misura: 200x150
Bacchette: 4 paragon da 10 mm
Fusto: Ø 27/30 mm
con bloccaggio e snodo
Colori: tinte unite
Materiale: poliestere 150 gr
Imballo: 5 pz

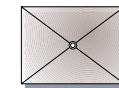

200 x 150 - 4 teli



B 934 INTRA

Misura: 200/8
Bacchette: 3,8 mm
Fusto: Ø 33 mm
con bloccaggio e snodo
Colori: tinte unite
Materiale: cotone 220 gr
Imballo: 10 pz

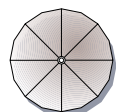

Ø 200 - 8 teli



B 941 INTRA

Misura: 200x150
Bacchette: 3,8 mm
Fusto: Ø 33 mm
con bloccaggio e snodo
Colori: tinte unite
Materiale: cotone 220 gr
Imballo: 5 pz

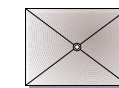

200 x 150 - 4 teli



B 937 RICCIONE

Misura: 200/8
Bacchette: 3,8 mm
Fusto: Ø 33 mm
con bloccaggio e snodo
Doubleface: interno in disegno
fantasia esterno in tinta unita
Materiale: cotone doubleface 230 gr
Imballo: 10 pz

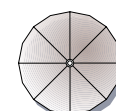

Ø 200 - 8 teli



H 948 ACRILICO

Misura: 200/8
Bacchette: 3,8 mm
Fusto: Ø 33 mm
con bloccaggio e snodo
Colori: tinta unita o rigato
Materiale: acrilico 190 gr
Imballo: 10 pz

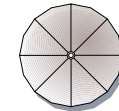

Ø 200 - 8 teli



G 960 OLEFIN

Misura: 200/8
 Bacchette: 3,8 mm
 Fusto: antracite Ø 33 mm
 con bloccaggio e snodo
 Colori: blu navy, blu royal, azzurro,
 verde acido, sabbia, antracite,
 rosso, mattone
 Materiale: olefin 190 gr -
 con alta protezione UV
 Bordino antracite - Imballo: 10 pz

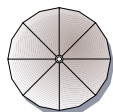

Ø 200 - 8 teli



G 960R OLEFIN MULTIRIGHE

Misura: 200/8
 Bacchette: 3,8 mm
 Fusto: antracite Ø 33 mm
 con bloccaggio e snodo
 Colori: rigati verde, ecrù
 Materiale: olefin 190 gr rigato,
 con alta protezione UV
 Bordino antracite
 Imballo: 10 pz

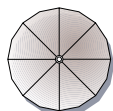

Ø 200 - 8 teli



D 942 TAHITI RAFIA

Misura: 200/8
 Bacchette: 3,2 mm
 Fusto: Ø 33 mm
 con bloccaggio e snodo
 Colori: tinte unite e melange
 Materiale: raffia - 6 giri
 Imballo: 4 pz

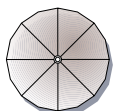

Ø 200 - 8 teli

D 945 TUKUL RAFIA

Misura: 200/8
 Bacchette: 3,2 mm
 Fusto: Ø 33 mm
 con bloccaggio e snodo
 Colori: tinte unite e melange
 Materiale: raffia - 7 giri
 Imballo: 4 pz

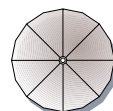

Ø 200 - 8 teli



E 589 BAGNINO POLIESTERE

Misura: 200/8
 Bacchette: zincate 4,5 mm
 Fusto: Ø 33/37 mm in alluminio
 con bloccaggio e snodo
 Colori: tinta unita
 Materiale: poliestere 150 gr
 Imballo: 5 pz

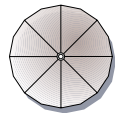

Ø 200 - 8 teli



H 951 BAGNINO ACRILICO

Misura: 200/8
 Bacchette: zincate 4,5 mm
 Fusto: Ø 33/37 mm in alluminio
 con bloccaggio e snodo
 Colori: tinta unita o rigato
 Materiale: acrilico 190 gr
 Imballo: 5 pz

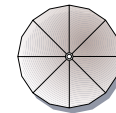

Ø 200 - 8 teli



G 961 BAGNINO OLEFIN

Misura: 200/8
 Bacchette: zincate 4,5 mm
 Fusto: Ø 33/37 mm in alluminio
 con bloccaggio e snodo
 Colori: blu navy, blu royal, azzurro, verde acido,
 sabbia, antracite, rosso, mattone
 Materiale: olefin 190 gr - con alta protezione UV
 Imballo: 5 pz

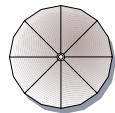

Ø 200 - 8 teli

G 961R BAGNINO OLEFIN MULTIRIGHE

Misura: 200/8
 Bacchette: zincate 4,5 mm
 Fusto: Ø 33/37 mm in alluminio
 con bloccaggio e snodo
 Colori: rigati verde, ecrù
 Materiale: olefin 190 gr
 con alta protezione UV
 Imballo: 5 pz

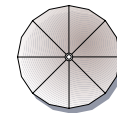

Ø 200 - 8 teli



G 964 BAGNINO OLEFIN FIBRA

Misura: 200/8
 Bacchette: Ø 6 mm in fiberglass
 Fusto: Ø 35/40 mm in alluminio
 con bloccaggio e snodo
 Colori: blu navy, blu royal, azzurro, verde acido,
 sabbia, antracite, rosso, mattone
 Materiale: olefin 190 gr - con alta protezione UV
 Imballo: 5 pz

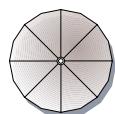

Ø 200 - 8 teli

G 964R BAGNINO OLEFIN FIBRA MULTIRIGHE

Misura: 200/8
 Bacchette: Ø 6 mm in fiberglass
 Fusto: Ø 35/40 mm in alluminio
 con bloccaggio e snodo
 Colori: rigati verde, ecrù
 Materiale: olefin 190 gr
 con alta protezione UV
 Imballo: 5 pz

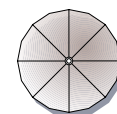

Ø 200 - 8 teli





G 962 - G 962R SCIROCCO PARAGON

Misura: 2x2 m
 Bacchette: 4 paragon da 10 mm
 Fusto: Ø 35/40 mm alluminio
 rigato anodizzato
 con bloccaggio a vite
 Tinte unite: blu navy, blu royal, azzurro, verde acido,
 sabbia, antracite, rosso, mattone
 Multirighe: rigati verde, ecrù
 Materiale: olefin 190 gr - con alta protezione UV
 Imballo: 5 pz

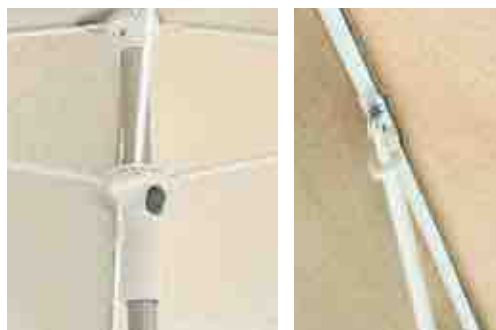

H max 2,66 m



200x200

G 965 - G 965R SCIROCCO FIBRA

Misura: 2x2 m
 Bacchette: 4 Ø 8 mm in fiberglass
 Fusto: Ø 35/40 mm alluminio
 rigato anodizzato
 con bloccaggio a vite
 Tinte unite: blu navy, blu royal, azzurro, verde acido,
 sabbia, antracite, rosso, mattone
 Multirighe: rigati verde, ecrù
 Materiale: olefin 190 gr rigato -
 con alta protezione UV
 Imballo: 5 pz



H max 2,66 m



200x200



G 963 - G 963R LIBECCIO

Misura: 250/10
 Bacchette: Ø 8 mm in fiberglass
 Fusto: Ø 35/40 mm alluminio rigato
 anodizzato con bloccaggio a vite
 Tinte unite: blu navy, blu royal, azzurro, verde acido,
 sabbia, antracite, rosso, mattone
 Multirighe: rigati verde, ecrù
 Materiale: olefin 190 gr - con alta protezione UV
 Imballo: 5 pz



H max 2,46 m

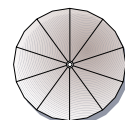

Ø 250 - 10 teli



G 966 - G 966R OLEFIN QUADRATO

Misura: 2,5x2,5 m
Bacchette: 4 paragon da 10 mm
Fusto: Ø 35/40 mm alluminio
rigato anodizzato
con bloccaggio a vite
Tinte unite: blu navy, blu royal, azzurro, verde acido,
sabbia, antracite, rosso, mattone
Multirighe: rigati verde, ecrù
Materiale: olefin 190 gr - con alta protezione UV
Imballo: 5 pz



H max 3,03 m



250x250



H 968 LEVANTE

Misura: 350/8
Bacchette: 15x20
Fusto: 48/48 mm alluminio
verniciato bianco
con bloccaggio a vite; apertura con carrucola
Tinte unite: blu, verde, marrone, bourdeaux,
rosso, arancio, giallo, ecrù, bianco
Materiale: acrilico 300 gr - con alta protezione UV
Imballo: 1 pz



H max 2,58 m

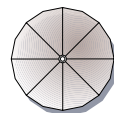

Ø 350 - 8 teli



H 969 TRAMONTANA

Misura: 3x3 m
 Bacchette: 15x20
 Fusto: 48/48 mm alluminio verniciato bianco
 con bloccaggio a vite; apertura con carrucola
 Tinte unite: blu, verde, marrone, bourdeaux, rosso, arancio, giallo, ecrù, bianco
 Materiale: acrilico 300 gr - con alta protezione UV
 Imballo: 1 pz



H max 3,25 m



300x300



H 970 GRECALE

Misura: 400/8
 Bacchette: 15x20
 Fusto: 48/48 mm alluminio verniciato bianco
 con bloccaggio a vite; apertura con carrucola
 Tinte unite: blu, verde, marrone, bourdeaux, rosso, arancio, giallo, ecrù, bianco
 Materiale: acrilico 300 gr - con alta protezione UV
 Imballo: 1 pz



H max 3,03 m



400 - 8 teli

OMBRELLONI DI PICCOLE DIMENSIONI



E 507 OMBRELLONE SDRAIO

Misura: 120/8
Fusto con morsetto
Materiale: poliestere rigato
Imballo: 30 pz



Ø 120 - 8 teli



A 645 PIC NIC NYLON

Misura: 134/6
Bacchette: 2,7 mm
Fusto: Ø 16/19 mm
con bloccaggio
Colori: rigati assortiti
con interno argento UV protection
Materiale: nylon
Imballo: 25 pz
Fornito con sacca in
PVC con tracolla



Ø 134 - 6 teli



A 503 OMBRELLONE PESCATORE

Misura: 170/8
Bacchette: 2,3 mm in fiberglass
Fusto: in fibra Ø 14 mm
con bloccaggio - in tre sezioni
Colori: verdone
Materiale: nylon
Imballo: 12 pz
Fornito con sacca in tessuto

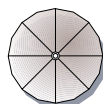

Ø 170 - 8 teli



A 695 NYLON ARLECCHINO

Misura: 180/8
Bacchette: 2,7 mm
Fusto: Ø 22/25 mm
con bloccaggio
Colori: arlecchino
Materiale: nylon
Imballo: 10 pz
Fornito con sacca in PVC
con tracolla

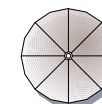

Ø 180 - 8 teli



A 646 NYLON RIGATO

Misura: 180/8
Bacchette: 2,8 mm
Fusto: Ø 32 mm
con bloccaggio e snodo
Colori: rigati assortiti
con interno argento UV protection
Materiale: nylon
Imballo: 10 pz
Fornito con sacca in
tessuto con tracolla

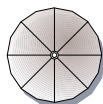

Ø 180 - 8 teli



A 648 NYLON RIGATO

Misura: 200/8
Bacchette: 3,1 mm
Fusto: Ø 32 mm
con bloccaggio e snodo
Colori: rigati assortiti
con interno argento UV protection
Materiale: nylon
Imballo: 10 pz
Fornito con sacca in
in tessuto con tracolla

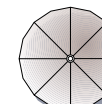

Ø 200 - 8 teli



G 995 SPUN

Misura: 180/8
Bacchette: 2,9 mm
Fusto: Ø 32 mm con
bloccaggio e snodo
Colori: rigati assortiti
Materiale: spun
Imballo: 10 pz
Fornito con sacca in PVC
con tracolla

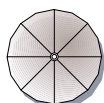

Ø 180 - 8 teli



B 920 ELBA

Misura: 200/8
Bacchette: 3,1 mm
Fusto: Ø 32 mm con
bloccaggio e snodo
Doubleface: interno in disegno fantasia
esterno in tinta unita (blu o verde)
Materiale: policotone 160 gr
Imballo: 10 pz assortiti

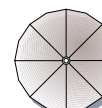

Ø 200 - 8 teli



E 502 STRIPE

Misura: 200/8
 Bacchette: 3,1 mm
 Fusto: Ø 32 mm con bloccaggio e snodo
 Colori: bianco/rosso, bianco/blu, bianco/arancio, bianco/verde bosco
 Materiale: poliestere 160 gr rigato
 Imballo: 10 pz assortiti
 Fornito con sacca in PVC con tracolla

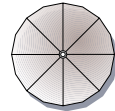

Ø 200 - 8 teli



E 502B STRIPE BIANCO/BLU

Misura: 200/8
 Bacchette: 3,1 mm
 Fusto: Ø 32 mm con bloccaggio e snodo
 Colori: bianco/blu
 Materiale: poliestere 160 gr rigato
 Imballo: 10 pz
 Fornito con sacca in PVC con tracolla



E 502F FANTASY

Misura: 200/8
 Bacchette: 3,1 mm
 Fusto: Ø 32 mm con bloccaggio e snodo
 Colori: fantasie assortita
 Materiale: poliestere 160 gr
 Imballo: 10 pz assortiti
 Fornito con sacca in PVC con tracolla

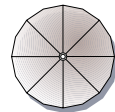

Ø 200 - 8 teli



E 594 PARAGGI

Misura: 220/8
 Bacchette: 5 mm in fiberglass
 Fusto: Ø 28/32 mm color legno scuro con bloccaggio
 Colore: ecru
 Materiale: poliestere 140 gr
 Imballo: 10 pz

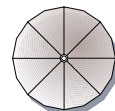

Ø 220 - 8 teli



E 511E POLI ECRU'

Misura: 200/8
 Bacchette: 5 mm in fiberglass
 Fusto: Ø 32 mm con bloccaggio e snodo
 Camino antivento
 Colore: ecru, con interno argento con alta protezione UV
 Materiale: poliestere 140 gr
 Imballo: 10 pz
 Fornito con sacca in tessuto con tracolla

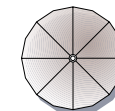

Ø 200 - 8 teli

Scatola di soli ecru (E) o di soli blu (B)



E 511 POLI

Misura: 200/8
 Bacchette: 5 mm in fiberglass
 Fusto: Ø 32 mm con bloccaggio e snodo
 Camino antivento
 Colore: rosso, blu, verdino, giallo con interno argento con alta protezione UV
 Materiale: poliestere 140 gr
 Imballo: 10 pz assortiti
 Fornito con sacca in tessuto con tracolla

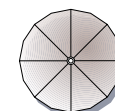

Ø 200 - 8 teli





E 593 MIRAMARE

Misura: 200/8
 Bacchette: 5 mm in fiberglass
 Fusto: Ø 32 mm con bloccaggio e snodo
 Camino antivento
 Colori: rigati assortiti
 Materiale: poliestere 140 gr, con interno argento
 con alta protezione UV
 Imballo: 10 pz assortiti
 Fornito con sacca in tessuto con tracolla

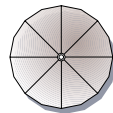

Ø 200 - 8 teli



E 515B CARRE'

Misura: 180x180
 Bacchette: 6 mm in acciaio
 Fusto: Ø 28/32 mm
 con bloccaggio
 Colore: blu
 Materiale: poliestere 160 gr
 Imballo: 6 pz per colore

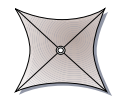

180x180 - 4 teli



A 647 OMBRELLONE CABINA

Misura: 200/8
 Bacchette: 4 mm
 Fusto: Ø 32 mm
 Colori: rossi e blu assortiti con interno
 argento con alta protezione UV
 Materiale: nylon
 Imballo: scatole da 6 pz
 Fornito con sacca in tessuto
 con tracolla e picchetti

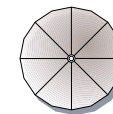

Ø 200 - 8 teli



E 525B LERICI

Misura: 200/8
 Bacchette: 5 mm in fiberglass
 Fusto: Ø 32 mm in alluminio
 con bloccaggio e snodo
 Camino antivento
 Colori: bianco/blu
 Materiale: poliestere 160 gr rigato
 Imballo: 10 pz
 Fornito con sacca in tessuto con tracolla

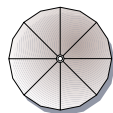

Ø 200 - 8 teli



E 525V LERICI

Misura: 200/8
 Bacchette: 5 mm in fiberglass
 Fusto: Ø 32 mm in alluminio
 con bloccaggio e snodo
 Camino antivento
 Colori: bianco/verdone
 Materiale: poliestere 160 gr rigato
 Imballo: 10 pz
 Fornito con sacca in tessuto con tracolla

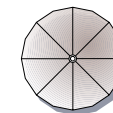

Ø 200 - 8 teli



E 522 NERVI

Misura: 240/6
 Bacchette: 10x4 mm
 Fusto: Ø 32 mm con bloccaggio
 Camino antivento
 Colori: rigato
 Materiale: poliestere 160 gr
 Imballo: 6 pz assortiti
 Fornito con sacca in PVC con tracolla

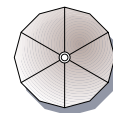

Ø 240 - 6 teli



E 521 MULTICOLOR

Misura: 240/16
 Bacchette: 5 mm in fiberglass
 Fusto: Ø 32 mm con bloccaggio e snodo
 Camino antivento
 Materiale: poliestere 180 gr multicolor
 Colori: multicolor con interno argento
 UV protection
 Imballo: 6 pz
 Fornito con sacca in tessuto con tracolla

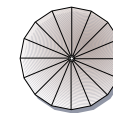

Ø 240 - 16 teli



854
Base in plastica
Tubo adatto a fusti 32/33 mm



856
Supporto a vite per ombrelloni
Adatto a fusti 32/33 mm
Fornito con adattatore per fusti
22/25 mm



857
Picchetto per ombrellone
Materiale: acciaio anodizzato
Adatto a fusti 32/33 mm



871
Palo inferiore con puntale a vite
Adatto a fusti 32 mm



Greenwood[®]



OMBRELLONI

Una vasta gamma di soluzioni di differenti misure, forme e colori compongono questa collezione, adatta a soddisfare le esigenze di tutta la clientela. Sono presenti articoli adatti ad uso professionale che ombrelloni pensati per un angolo relax in giardino o in terrazza.



ART. 5004

Ombrellone quadrato 2,2x2,2 m.
4 bacchette da 12x18 mm.
Palo Ø 38/35 mm.
Con snodo e bloccaggio
Fusto color bianco
Poliestere 180 gr.
Ecrù - Con antivento

H max 2,50 m

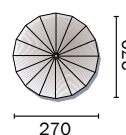

ART. E 590 KYOTO

Ombrellone rotondo Ø 2,70 m. a cupola
16 bacchette da 4 mm.
Palo Ø 34/37 mm. con bloccaggio
Fusto in alluminio antracite con manovella
Poliestere 180 gr.
Tinta unita ecrù,
verde, terracotta - Con antivento



OMBRELLONI IN
ALLUMINIO CON
PALO CENTRALE

H max 2,50 m

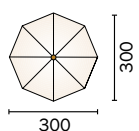

ART. 5000
Ombrellone rotondo Ø 3 m.
8 bacchette da 12x22 mm.
Palo Ø 48 mm. - con manovella
Fusto bianco
Poliestere 180 gr.
Ecrù - Con volante e antivento

H max 2,70 m

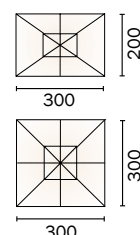

ART. 5006
Ombrellone rettangolare 3x2 m.
6 bacchette da 12x18 mm.
Palo Ø 38 mm - con manovella
Fusto grigio antracite
Poliestere 180 gr. - Ecrù
Con volante e antivento

ART. 5007
Ombrellone quadrato 3x3 m.
8 bacchette da 12x22 mm.
Palo Ø 48 mm. - con manovella
Fusto grigio antracite
Poliestere 180 gr. - Ecrù
Con volante e antivento



**CONNESSIONE
BLUETOOTH**

H max 2,50 m

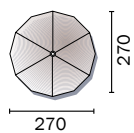

H max 2,80 m

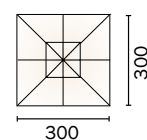

ART. 5032

Ombrellone rotondo Ø 2,70 m.
con luce a led sulle bacchette e luce centrale
Connessione bluetooth con cassa integrata
alimentata a pannello solare
6 bacchette da 14x20 mm.
Fusto in ferro grigio antracite Ø 38 mm. con snodo
Poliestere 180 gr. - Ecrù - Con antivento

ART. 5051

Ombrellone quadrato 3x3 m.
CONTRACT - Palo Ø 48 mm
8 bacchette 18x28 mm
Doppia carrucola manuale
con fermascotta
Fusto bianco
Poliestere resinato 240 gr.
Ecrù - Con volante e antivento



OMBRELLONI IN
ALLUMINIO CON
PALO CENTRALE

H max 3,15 m

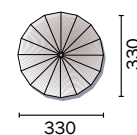

ART. 5039

Ombrellone rotondo Ø 3,30 m. a cupola CONTRACT
8 bacchette curve 17x22 mm.

Palo Ø 48 mm.

Apertura con carrucola

Fusto effetto legno

Poliestere 220 gr. - Ecrù

Con antivento

Greenwood®



OMBRELLONI IN ALLUMINIO
CON PALO CENTRALE

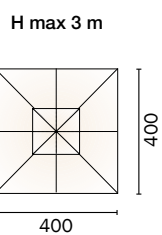

ART. 5041
Ombrellone quadrato 4x4 m. CONTRACT
Palo telescopico Ø 67 mm. - con manovella
8 bacchette 18x30 mm.
Fusto bianco - Base a croce (piastrelle non incluse)
Poliestere resinato 300 gr. - Ecrù
Con volante e antivento



H max 3,15 m

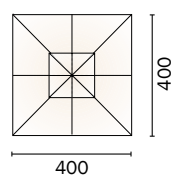

ART. 5030

Ombrellone quadrato 4x4 m. CONTRACT
 Palo telescopico Ø 80 mm. - con manovella
 8 bacchette 18x28 mm. - Fusto bianco
 Base a croce (piastrelle non incluse)
 Poliestere resinato 300 gr. - Tortora
 Con volante e antivento





**OMBRELLONI
IN ACCIAIO
CON PALO
LATERALE**

H max 2,60 m

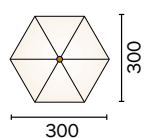

ART. 5042
Ombrellone rotondo Ø 3 m.
6 bacchette 12x18 mm.
Palo Ø 48 mm.
Fusto color grigio antracite
Base a croce (piastrelle non incluse)
Poliestere 180 gr. - Ecrù
Con antivento

H max 2,60 m

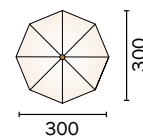

ART. 5013
Ombrellone rotondo Ø 3 m.
Palo Ø 48 mm. - 8 bacchette 12x18 mm.
con manovella
Fusto in alluminio color antracite
Base a croce (piastrelle non incluse)
Poliestere 180 gr. - Ecrù
Con volante e antivento



OMBRELLONI IN ALLUMINIO
CON PALO LATERALE

H max 2,62 m

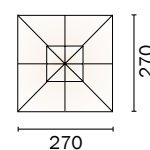

ART. 5033

Ombrellone quadrato 2,7x2,7 m.
Palo Ø 48 mm. - 8 bacchette 12x18 mm.
con manovella
Fusto in alluminio color antracite
Base a croce (piastrelle non incluse)
Poliestere 180 gr. - Ecrù
Con antivento

Greenwood®



OMBRELLONI IN ALLUMINIO
CON PALO LATERALE

H max 2,60 m

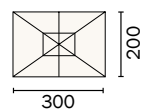

ART. 5015
Ombrellone rettangolare 3x2 m.
Palo Ø 45X65 mm. - 6 bacchette 12x22 mm.
con manovella - Fusto grigio antracite
Poliestere 180 gr. - Ecrù

Con volante e antivento
Base a croce (piastrelle non incluse)



H max 2,63 m

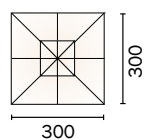

H max 2,63 m

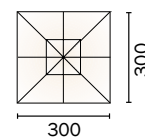

ART. 5011

Ombrellone quadrato 3x3 m.
 Palo 45x65 mm. - 8 bacchette 12x22 mm.
 con manovella - Fusto grigio antracite
 Poliestere 180 gr. - Ecrù
 Con volante e antivento
 Base a croce (piastrelle non incluse)

ART. 5011B

Ombrellone quadrato 3x3 m.
 Palo 45x65 mm. - 8 bacchette 12x22 mm. - con manovella
 Fusto bianco - Poliestere 180 gr. - Bianco
 Con volante e antivento
 Base a croce (piastrelle non incluse)

OMBRELLONI IN
ALLUMINIO CON
PALO LATERALE



H max 2,62 m

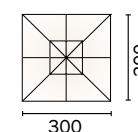

ART. 5023
Ombrellone quadrato LUCI 3x3 m.
Palo 45x65 mm. - con manovella
8 bacchette 14x20 mm. con LED + faretto centrale
alimentato da pannello solare

Fusto grigio antracite
Poliestere 210 gr. - Resinato - Ecrù
Con antivento
Base a croce (piastrelle non incluse)



H max 2,58 m

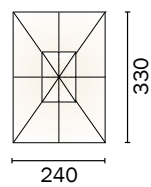

ART. 5034
 Ombrellone rettangolare 2,4x3,3 m.
 Palo 71x51 mm. - 8 bacchette 12x22 mm.
 con manovella
 Fusto grigio antracite

Poliestere 200 gr. - Color sabbia
 Con antivento
 Base a croce (piastrelle non incluse)



H max 2,68 m

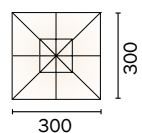

ART. 5024

Ombrellone quadrato 3x3 m. con maniglione
 Palo 77x53 mm. - 8 bacchette 14x24x0,8 mm.
 Fusto antracite - Ruotabile 360°
 Poliestere 200 gr. - Ecrù
 Con antivento
 Base a croce (piastrelle non incluse)

H max 2,68 m

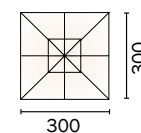

ART. 5024T

Ombrellone quadrato 3x3 m. con maniglione
 Palo 77x53 mm. - 8 bacchette 14x24x0,8 mm.
 Fusto bianco - Ruotabile 360°
 Poliestere 200 gr. - Tortora
 Con antivento
 Base a croce (piastrelle non incluse)



OMBRELLONI IN ALLUMINIO
CON PALO LATERALE



H max 2,73 m

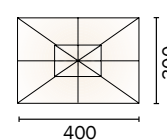

ART. 5037
Ombrellone rettangolare 3x4 m. con maniglione
Palo in alluminio Ø 77x53 mm.
8 bacchette 17x25x1 mm.
Fusto antracite - Ruotabile 360°
Poliestere 220 gr. - Ecrù
Base a croce (piastrelle non incluse)
Con antivento

Greenwood®



H max 2,85 m

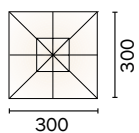

ART. 5014
 Ombrellone quadrato 3x3 m. CONTRACT
 Fusto bianco Ø 80 mm. - con manovella
 8 bacchette 26x13x1,3 mm. - Poliestere 240 gr.
 Color ecru - Con volante e camino antivento
 Base a croce (piastrelle non incluse)

H max 2,85 m

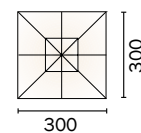

ART. 5014L
 Ombrellone quadrato 3x3 m. CONTRACT
 CON LUCI alimentate da pannello solare
 Led integrati nelle stecche e faretto centrale
 Fusto bianco Ø 80 mm. - con manovella
 8 bacchette 26x13x1,3 mm. - Poliestere 240 gr.
 Color ecru - Con camino antivento
 Base a croce (piastrelle non incluse)



OMBRELLONI IN ALLUMINIO
CON PALO LATERALE

H max 2,80 m

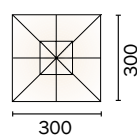

ART. 5028 E
Ombrellone quadrato 3x3 m. CONTRACT
con maniglione e fodero
Palo in alluminio ovale 90x51 mm.
8 bacchette 16x28 mm. - ruotabile a 360°
Fusto argento - Poliestere 300 gr. - Ecrù
Con antivento
Base a croce (piastrelle non incluse)



H max 2,80 m

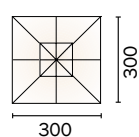

ART. 5044
 Ombrellone quadrato 3x3 m. CONTRACT
 Palo in alluminio 110x68 mm. con maniglione
 8 bacchette 20x35 mm. - Fusto alluminio anodizzato
 Ruotabile 360°

Poliestere 250 gr. - Ecrù
 Con fodero
 Base a croce (piastrelle non incluse)



OMBRELLONI IN ALLUMINIO
CON PALO LATERALE

H max 3,25 m

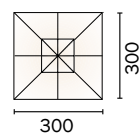

ART. 5045
Ombrellone quadrato 3x3 m. CONTRACT
Palo in alluminio 70x70mm. con manovella
8 bacchette 17x28 mm. - Fusto verniciato effetto legno
Ruotabile 360° - Poliestere 220 gr. resinato - Ecrù
Con antivento
Base a croce (piastrelle non incluse)



**OMBRELLONI IN
ALLUMINIO CON
PALO LATERALE**

ART. 5038

Ombrellone quadrato 3,5x3,5 m. CONTRACT
Palo in alluminio 93x93 mm./70x70 mm. con manovella
8 bacchette 17x35 mm. rinforzate
Fusto in alluminio effetto legno
Ruotabile 360° - Poliestere 360 gr. - Sabbia
Con antivento
Base a due piastrelle in ceramica comprese



H max 3,40 m

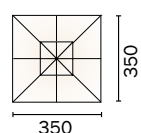

ART. 5038 S

Ombrellone quadrato 3,5x3,5 m. CONTRACT
Palo in alluminio 93x93 mm./70x70 mm. con manovella
8 bacchette 17x35 mm. rinforzate
Fusto in alluminio effetto legno sbiancato

Ruotabile 360° - Poliestere 360 gr. - Tortora
Con antivento
Base a due piastrelle in ceramica bianca comprese



SACCHE PER OMBRELLONI

ART. AC 002
Sacca ricovero per
ombrellone palo laterale
ecrù con velcro



ART. AC 001
Sacca ricovero per ombrelloni
palo laterale grandi
grigia con cerniera



OMBRELLONI IN LEGNO
CON PALO CENTRALE

H max 2,47 m

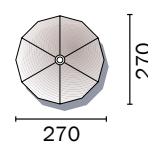

ART. 1014
Ombrellone rotondo Ø 2,70 m.
Bastone Ø 38/6 in 2 pezzi
Bacchette 14x24 mm.
Legno color teak
Poliestere 180 gr. rigato
Con antivento



SERIE STANDARD

H max 2,54 m

H max 2,65 m

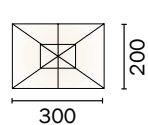
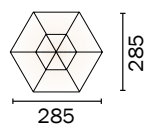

ART. 1000

Ombrellone rotondo Ø 2,85 m.
Bastone Ø 48/6 in 2 pezzi
Bacchette 14x24 mm.
Legno color teak - doppia carrucola
Poliestere 180 gr. - Ecrù
Con volante e antivento

ART. 1005

Ombrellone rettangolare 3x2 m.
Bastone Ø 48/6 in 2 pezzi
Bacchette 14x24 mm.
Legno color teak - doppia carrucola
Poliestere 180 gr. - Ecrù
Con volante e antivento

H max 2,93 m

H max 2,71 m

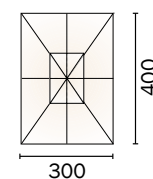
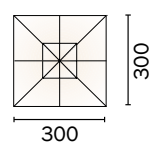

ART. 1003

Ombrellone quadrato 3x3 m.
Bastone Ø 48/8 in 2 pezzi
Bacchette 17x23 mm.
Legno color teak - due doppie carrucole
Poliestere 180 gr. - Ecrù
Con volante e antivento

ART. 1001

Ombrellone rettangolare 3x4 m.
Bastone Ø 48/8 in 2 pezzi
Bacchette 17x23 mm.
Legno color teak - due doppie carrucole
Poliestere 180 gr. - Ecrù
Con volante e antivento



DE LUX

H max 2,76 m

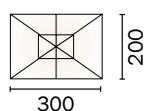

H max 2,78 m

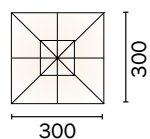

ART. 4002

Ombrellone quadrato 3x3 m.
Bastone Ø 48/8 palo unico
Legno color teak - due doppie carrucole
bacchette 20x24 mm.
Finiture in ottone - Poliestere 230 gr.
Verde, ecrù
Con volante e antivento

ART. 4001

Ombrellone rettangolare 3x2 m.
Bastone Ø 48/6 palo unico
Legno color teak - due doppie carrucole
bacchette 20x24 mm.
Finiture in ottone - Poliestere 230 gr.
Verde, ecrù
Con volante e antivento

H max 2,89 m

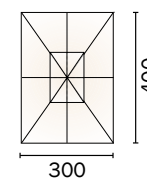

ART. 4004

Ombrellone rettangolare 3x4 m.
Bastone Ø 48/8 palo unico
Legno color teak - due doppie carrucole
Bacchette 20x24 mm.
Finiture in ottone - Poliestere 230 gr.
Verde, ecrù
Con volante e antivento



SERIE EXTRA

H max 2,95 m

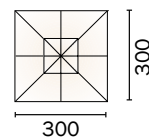

H max 2,65 m

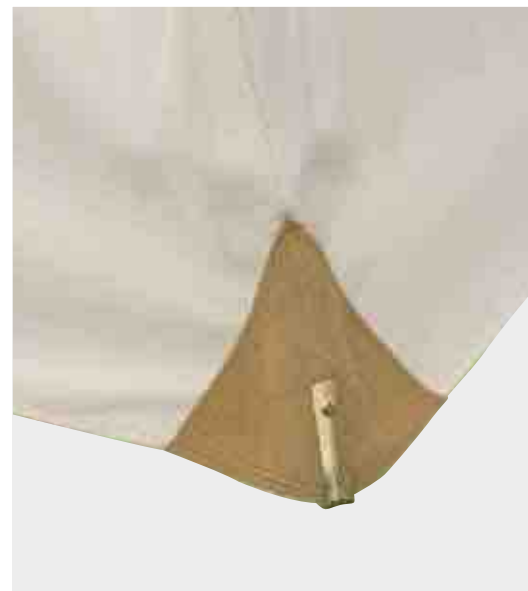
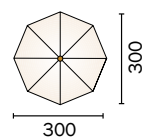

ART. 4008

Ombrellone quadrato 3x3 m.
 Bastone Ø 48/8 - Palo unico
 Legno indonesiano - Bacchette 17x28 mm.
 Finiture in ottone e angoli in pelle
 Poliestere 270 gr. - Ecrù, terracotta, verde
 Con antivento



ART. 4000

Ombrellone rotondo Ø 3 m.
 Bastone Ø 38/8 in 2 pezzi
 Legno indonesiano - Bacchette 17x22 mm.
 Finiture in ottone e angoli in pelle
 Poliestere 270 gr.
 Ecrù, terracotta, verde
 Con antivento

BASI PER OMBRELLONI

ARTICOLO	CARATTERISTICHE	
	<p>855</p> <p>Base in plastica con ruote litri 50 Tubo adattabile</p>	
	<p>1073</p> <p>Base Diamante in cemento Rubber Nero Kg 25 - Tubo Ø 48 mm con riduzione</p>	
	<p>1025</p> <p>Base in granigietto Kg 25 - Ø 45 cm Tubo Ø 55 mm</p>	
	<p>1055</p> <p>Base in granigietto Kg 50 - Ø 60 cm Tubo Ø 55 mm</p>	
	<p>1060</p> <p>Base in granigietto con maniglie Kg 50 - Ø 60 cm Tubo Ø 55 mm Maniglie in acciaio</p>	
	<p>1061</p> <p>Base in cemento con ruote Colore verde Kg 37 - 50 x 50 cm Tubo adattabile da Ø 35 a Ø 48 mm 4 ruote e maniglie</p>	



moia

GAZEBO

Ideali elementi d'arredo da giardino realizzati con materiali che ne garantiscono la resistenza, ogni dettaglio è studiato per offrire estetica, praticità d'utilizzo ed installazione. Il design dalle linee semplici o classiche aggiunge a questa gamma di prodotti la varietà di scelta.



**GAZEBO
PIEGHEVOLI**



Art. GAZ 134
Gazebo quadrato 3x3 m. pieghevole in ferro
verniciato epoxy
Poliestere 160 gr. resinato ecrù
con sacca per il trasporto



Art. GAZ 133
Gazebo quadrato 3x3 m. pieghevole
in alluminio
Poliestere 180 gr. resinato ecrù
con sacca per il trasporto



Art. GAZ 111

Gazebo rettangolare 3x2 m. pieghevole con gambe in alluminio e con traliccio centrale in ferro
 Poliestere 250 gr. ecrù con interno spalmato in pvc con 4 tende laterali con sacca per il trasporto



Art. GAZ 104

Gazebo quadrato 3x3 m. pieghevole con gambe in alluminio e traliccio in ferro verniciato epoxy
 Poliestere 160 gr. ecrù con sacca per il trasporto

Art. COP 104

Tende laterali in optional



**GAZEBO
PIEGHEVOLI**

Art. GAZ 105
Gazebo quadrato 3x3 m. pieghevole
con traliccio centrale in alluminio
Poliestere 300 gr. impermeabilizzato bianco
con 4 tende laterali con sacca per il trasporto



Art. GAZ 107
Gazebo pieghevole rettangolare 3x4,5 m.
in alluminio con traliccio centrale
Poliestere 300 gr. impermeabilizzato bianco
con 4 tende laterali con sacca per il trasporto

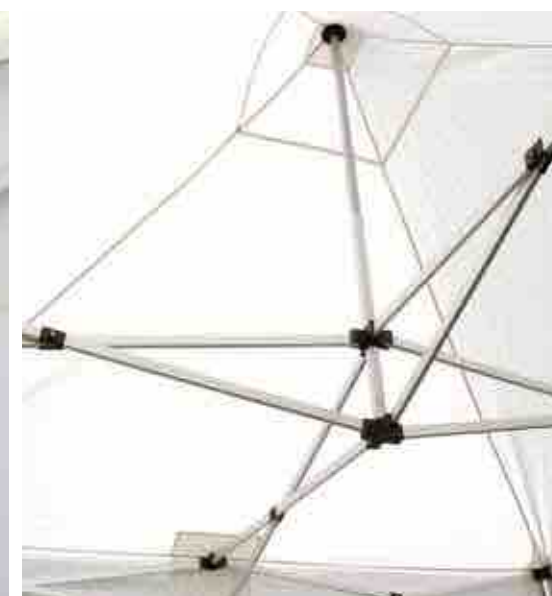

Art. GAZ 106
 Gazebo rettangolare 6x3 m. pieghevole
 in alluminio con traliccio centrale
 Poliestere 300 gr. impermeabilizzato bianco
 con 6 tende laterali con sacca per il trasporto

Accessori:
AC 110 Set 2 tende laterali
AC 109 Tendalino
AC 107 Tavolo pieghevole 300x40 cm

Art. GAZ 110
 Gazebo quadrato 3 x 3 m. Mercato
 Struttura in alluminio esagonale 40 mm.
 con traliccio centrale
 Poliestere 300 gr. bianco
 impermeabilizzato e interno in PVC
 con sacca per il trasporto



GAZEBO A TUBO



Art. GAZ 132
Gazebo Promo quadrato 3 x 3 m.
Struttura a tubo Ø 25-19 mm.
in ferro epoxy bianco
Telo plastificato 100 gr. bianco



GAZEBO A TUBO



Art. GAZ 160
Gazebo Car Parking rettangolare 6x3 m.
Struttura a tubo Ø 38 mm.
in ferro epoxy bianco
Telo plastificato 180 gr. bianco
con pareti laterali e finestre



GAZEBO IN ALLUMINIO



Art. GAZ 172
Tendone 9x6,50 m.
Struttura pali Ø 34 mm. in ferro epoxy bianco
Poliestere 300 gr. spalmato PVC ecrù
Completo di tende laterali in poliestere 160 gr.
con finestre in PVC trasparente e due porte



Art. GAZ 171
Tendone rettangolare 12x6 m.
Struttura a tubo Ø 50 mm. in ferro galvanizzato
Telo in PVC 480 gr. bianco con trattamento
ignifugo 3M e pareti laterali con finestre



GAZEBO IN ALLUMINIO



Art. GAZ 035
 Gazebo quadrato 3x3 m.
 Struttura pali Ø 100 mm. in alluminio antracite
 Poliestere 350 gr. resinato ecrù - con antivento
 Completo di tende laterali



Art. AC 032
 Tende mosquito in optional



Art. GAZ 034
 Gazebo rettangolare 3x4 m.
 Struttura pali triangolare 100 x 100 x 130 mm.
 in alluminio antracite
 Poliestere 350 gr. resinato ecrù - con antivento
 Completo di tende laterali

Art. AC 031
 Tende mosquito in optional



GAZEBO IN ALLUMINIO



Art. GAZ 063

Gazebo rettangolare 6x3 m.
Struttura pali Ø 100 mm. antracite
Poliestere 350 gr. resinato ecrù
Con antivento e volante color biscotto
Completo di tende laterali

Art. AC 063

Tende mosquito in optional



GAZEBO IN FERRO



Art. GAZ 363

Gazebo rettangolare 3x2 m. senza viti
Struttura pali 38 x 38 mm.
in ferro epoxy antracite
Poliestere 180 gr. color ecrù
Innesti a molla - con antivento



GAZEBO IN FERRO



Art. GAZ 365

Gazebo quadrato 3x3 m. senza viti
Struttura pali 38x38 mm.
in ferro epoxy antracite
Poliestere 180 gr. color ecrù
Innesti a molla - con antivento



Art. GAZ 361
Pergola a parete 4x3 m.
Struttura pali 40x40 mm.
in ferro epoxy antracite
Poliestere 180 gr.color sabbia



GAZEBO IN FERRO



Art. GAZ 366
Gazebo quadrato 3x3 m.
Struttura pali 60x60 mm.
in ferro epoxy bianco
Poliestere resinato 180 gr. color ecrù - con antivento
Tende laterali color ecrù

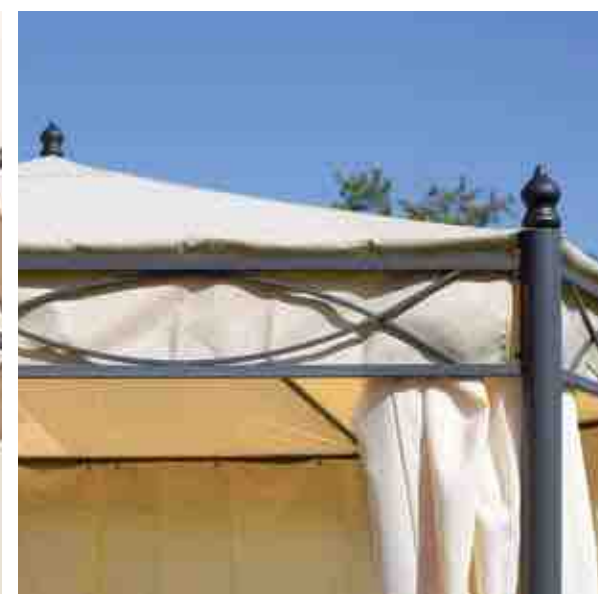

Art. GAZ 370
Gazebo esagonale Ø 4 m.
Struttura pali Ø 60 mm. in ferro epoxy antracite
Poliestere 210 gr. resinato color sabbia - con antivento
Tende laterali color ecrù



Art. GAZ 371
Gazebo quadrato 3x3 m.
Struttura pali Ø 72 mm. in ferro epoxy antracite
Poliestere 210 gr. resinato color sabbia - con antivento
Tende laterali ecrù e tende mosquito



GAZEBO IN FERRO



Art. GAZ 372

Gazebo rettangolare 3x4 m.

Struttura pali Ø 72 mm. in ferro epoxy antracite

Poliestere 210 gr. resinato color sabbia - con antivento

Tende laterali color ecrù e tende mosquito



GAZEBO IN FERRO



Art. GAZ 364
Gazebo quadrato 3x3 m. estendibile fino a 5x3 m.
Struttura 60x60 mm. in ferro epoxy antracite
Poliestere 180 gr. resinato color ecrù - con antivento
Tende laterali ecrù



TENDE BUTTERFLY



Art. GAZ 506
Tenda Butterfly 4x4 m.
Struttura Ø 60 mm. in ferro epoxy ecrù
Poliestere resinato 200 gr. bianco



PERGOLE



Art. GAZ 502
Pergola con tetto scorrevole 3,5x2,5 m.
Struttura 4 pali 80x80 mm.
in ferro epoxy bianco
Poliestere 180 gr. bianco



Art. GAZ 503
Pergola con tetto scorrevole 3x3 m.
Struttura 4 pali in ferro 73x73 mm e travi
in alluminio color antracite
Poliestere 200 gr. grigio



PERGOLE



Art. GAZ 507
Gazebo Milano 3,5x4 m.
Struttura in ferro epoxy bianco Ø 57 mm.
Poliestere 250 gr. ecrù



MARQUISE



Art. GAZ 504
Marquise 4x4 m.
Struttura in ferro epoxy bianco
Poliestere resinato 280 gr. rigato
Base a croce (piastrelle non incluse)



Art. GAZ 505
Marquise deluxe 4x3 m.
Struttura in alluminio bianco 65x70 mm.
Poliestere 280 gr. con
impermeabilizzazione PU bianco
Basamento con piastra in acciaio



VELE



Art. VE 11
 Vela 5x5x5 m.
 Poliestere resinato 180 gr. colore ecrù
 Tre corde da 3,5 m.

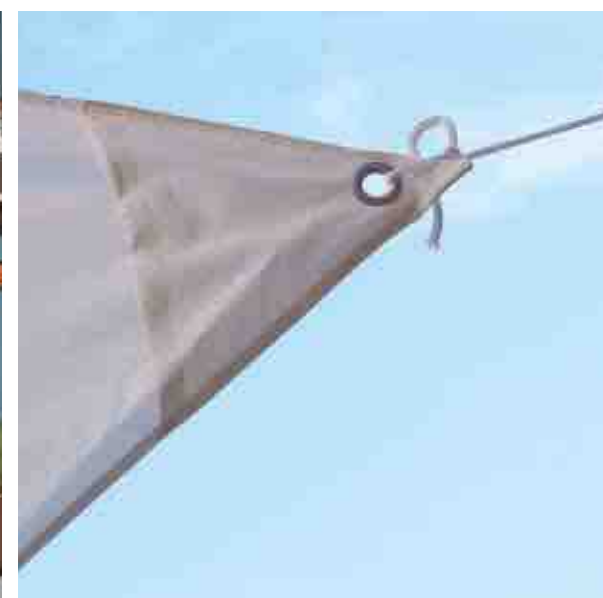

Art. VE 10
 Vela 3,6x3,6x3,6 m.
 Poliestere resinato 180 gr. colore ecrù
 Tre corde da 3,5 m.

GAZEBO PIEGHEVOLI



ARTICOLO	DESCRIZIONE	MATERIALE	DIMENSIONI	DISEGNO TECNICO
GAZ 134	Gazebo quadrato 3x3 m pieghevole Portatile	Poliestere resinato 160 gr. ecrù Struttura in ferro 25 x 25 mm. / 20 x 20 mm. Con sacca per il trasporto	Base 300 Profondità 300	
GAZ 133	Gazebo quadrato 3x3 m pieghevole	Poliestere resinato 180 gr. ecrù Struttura in alluminio 25 x 25 mm. / 20 x 20 mm. Con sacca per il trasporto	Base 300 Profondità 300	
GAZ 111	Gazebo rettangolare 3x2 m pieghevole	Poliestere 250 gr. ecrù con interno spalmato in PVC Struttura con gambe in alluminio e traliccio centrale in ferro 30 x 30 mm. / 25 x 25 mm. Con sacca per il trasporto	Base 300 Profondità 200	
GAZ 104	Gazebo folding 3x3 m pieghevole	Poliestere 160 gr. - ecrù, , tende laterali Struttura in alluminio Pali: 30 x 30 - 25 x 25 mm. x 1 Traliccio: 22 x 10 x 1,2 mm. Con sacca per il trasporto	Base 300 Profondità 300	
GAZ 105	Gazebo quadrato 3x3 m pieghevole	Poliestere 300 gr. resinato - bianco con traliccio centrale, tende laterali Struttura in alluminio Pali: 29 x 29 - 25 x 25 mm. Traliccio: 22 x 10 x 1,2 mm. Con sacca per il trasporto	Base 300 Profondità 300	
GAZ 107	Gazebo rettangolare 3x4,5 m pieghevole	Poliestere 300 gr. impermeabilizzato - bianco, con traliccio centrale, tende laterali Struttura in alluminio Pali: 29 x 29 - 25 x 25 mm. Traliccio: 22 x 10 x 1,2 mm. Con sacca per il trasporto	Base 450 Profondità 300	
GAZ 106	Gazebo rettangolare 6x3 m pieghevole	Poliestere 300 gr. resinato - bianco con traliccio centrale, tende laterali Struttura in alluminio Pali: 29 x 29 - 25 x 25 mm. Traliccio: 22 x 10 x 1,2 mm. Con sacca per il trasporto	Base 600 Profondità 300	
GAZ 110	Gazebo quadrato 3x3 m Mercato Accessori: AC 110 Set 2 tende laterali AC 109 Tendalino AC 107 Tavolo pieghevole 300x40 cm	Poliestere 300 gr. impermeabilizzato - bianco interno in PVC Struttura in alluminio esagonale 40 mm. con traliccio centrale Con sacca per il trasporto	Base 300 Profondità 300	

GAZEBO CON STRUTTURA A TUBO



ARTICOLO	DESCRIZIONE	MATERIALE	DIMENSIONI	DISEGNO TECNICO
GAZ 132	Gazebo Promo quadrato 3x3 m	Telo plastificato 100 gr. bianco Struttura in ferro bianco Ø 25/19 mm.	Base 300 Profondità 300	



GAZ 160	Gazebo Car Parking rettangolare 6x3 m	Telo plastificato 180 gr. bianco con pareti laterali con finestre Struttura in ferro epoxy bianco Ø 38 mm.	Base 600 Profondità 300	
---------	--	---	----------------------------	--



GAZ 172	Tendone 9x6,5 m	Poliestere 300 gr. spalmato PVC ecrù Completo di tende laterali in poliestere 160 gr. con finestre in PVC trasparente e due porte Struttura pali Ø 34 mm. in ferro epoxy bianco	Base 900 Profondità 650	
---------	------------------------	---	----------------------------	--



GAZ 171	Tendone rettangolare 12x6 m	Telo PVC 480 gr. bianco con trattamento ignifugo 3M, con pareti laterali con finestre Struttura in ferro galvanizzato Ø 50 mm.	Base 1200 Profondità 600	
---------	------------------------------------	---	-----------------------------	--

GAZEBO CON STRUTTURA IN ALLUMINIO



ARTICOLO	DESCRIZIONE	MATERIALE	DIMENSIONI	DISEGNO TECNICO
GAZ 035	Gazebo quadrato 3x3 m	Poliestere 350 gr. resinato - ecrù con camino antivento Struttura Ø 100 mm in alluminio verniciato epoxy antracite con tende laterali	Base 300 Profondità 300	



GAZ 034	Gazebo rettangolare 3x4 m	Poliestere 350 gr. resinato - ecrù con camino antivento Struttura palo triangolare 130x100x100 mm in alluminio verniciato epoxy antracite con tende laterali	Base 400 Profondità 300	
---------	----------------------------------	---	----------------------------	--



GAZ 063	Gazebo rettangolare 6x3 m	Poliestere 350 gr. resinato - ecrù con antivento e volante biscotto Struttura Ø 100 mm. in alluminio verniciato epoxy grigio antracite con tende laterali	Base 600 Profondità 300	
---------	----------------------------------	--	----------------------------	--

GAZEBO IN FERRO



ARTICOLO	DESCRIZIONE	MATERIALE	DIMENSIONI	DISEGNO TECNICO
GAZ 363	Gazebo rettangolare 3x2 m senza viti	Poliestere 180 gr. resinato color ecrù con antivento Struttura in ferro epoxy antracite 38x38 mm. con innesti a molla	Base 300 Profondità 200	



GAZ 365	Gazebo quadrato 3x3 m senza viti	Poliestere resinato 180 gr. color ecrù con antivento Struttura in ferro epoxy antracite 38x38 mm. con innesti a molla	Base 300 Profondità 300	
---------	-------------------------------------	---	----------------------------	--



GAZ 361	Pergola a parete 3x4 m	Poliestere 180 gr. sabbia Struttura 40x40 mm. in ferro epoxy grigio antracite	Base 400 Profondità 300	
---------	------------------------	---	----------------------------	--



GAZ 366	Gazebo quadrato 3x3 m	Poliestere resinato 180 gr. ecrù con antivento Struttura 60x60 mm. in ferro epoxy bianco	Base 300 Profondità 300	
---------	--------------------------	---	----------------------------	--



GAZ 370	Gazebo esagonale Ø 4 m	Poliestere resinato 210 gr. con antivento Copertura sabbia tende laterali ecrù Struttura Ø 60 mm in ferro verniciato epoxy antracite	Diametro 400	
---------	---------------------------	---	--------------	--



GAZ 371	Gazebo quadrato 3x3 m	Poliestere resinato 210 gr. con antivento Copertura sabbia - tende laterali ecrù e tende mosquito Struttura Ø 72 mm in ferro verniciato epoxy antracite	Base 300 Profondità 300	
---------	--------------------------	---	----------------------------	--



GAZ 372	Gazebo rettangolare 3x4 m	Poliestere resinato 210 gr. con antivento Copertura sabbia - tende laterali ecrù e tende mosquito Struttura Ø 72 mm in ferro verniciato epoxy antracite	Base 400 Profondità 300	
---------	------------------------------	---	----------------------------	--



GAZ 364	Gazebo quadrato 3x3 m estendibile fino a 5 m	Poliestere resinato 180 gr. con antivento Copertura ecrù - tende laterali ecrù Struttura 60x60 mm in ferro epoxy antracite	Base 300 + 200 Profondità 300	
---------	--	---	----------------------------------	--



ARTICOLO	DESCRIZIONE	MATERIALE	DIMENSIONI	DISEGNO TECNICO
GAZ 506	Tenda butterfly 4x4 m	Poliestere 200 gr. resinato color bianco Struttura in ferro epoxy bianco Ø 60 mm.	Base 400 Profondità 400 Altezza massima 308 Altezza minima 222	



GAZ 502	Pergola con tetto 3,5x2,5 m	Poliestere 180 gr. color bianco Struttura 4 pali in ferro 80x80 mm. epoxy bianco	Base 350 Profondità 250 Altezza 226	
---------	--	---	---	--



GAZ 503	Pergola con tetto scorrevole 3x3 m	Poliestere 200 gr. color grigio antracite Struttura 4 pali in ferro 73x73 mm. e travi in alluminio 50x31 mm. color antracite	Base 300 Profondità 300 Altezza 234	
---------	---	---	---	--



GAZ 507	Gazebo Milano 3,5x4 m	Poliestere 250 gr. color ecrù Struttura 4 pali in ferro bianco Ø 57 mm.	Base 400 Profondità 350 Altezza massima 262 Altezza minima 216	
---------	----------------------------------	--	---	--



GAZ 504	Marquise 4x4 m	Poliestere resinato 280 gr. rigato Struttura in ferro epoxy color bianco Piastrelle escluse	Base 400 Profondità 400 Altezza massima 267	
---------	---------------------------	---	---	--

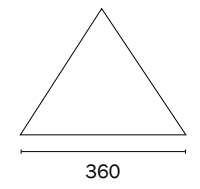
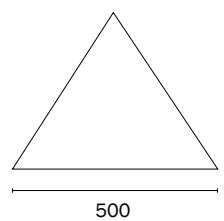

GAZ 505	Marquise deluxe 4x3 m	Poliestere 280 gr. con impermeabilizzazione PU Struttura in alluminio bianco 65x70 mm. Basamento con piastra in acciaio	Base 442 Profondità 326 Altezza massima 260	
---------	----------------------------------	---	---	--

ARTICOLO	DESCRIZIONE	MATERIALE	DIMENSIONI		DISEGNO TECNICO
VE 10	Vela 3,6x3,6x3,6 m	Poliestere resinato 180 gr. - ecrù con tre corde da 3,5 m	Base	360	
VE 11	Vela 5x5x5 m	Poliestere resinato 180 gr. - ecrù con tre corde da 3,5 m	Base	500	



moia 

DONDOLI

Ideali elementi d'arredo da giardino realizzati con materiali che ne garantiscono la resistenza, ogni dettaglio è studiato per offrire estetica, praticità d'utilizzo ed installazione. Il design dalle linee semplici o classiche aggiunge a questa gamma di prodotti la varietà di scelta.

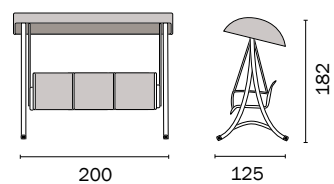

Art. SV 116
 Dondolo 3 posti
 Tubo in ferro Ø 48 mm bianco
 Seduta in textilene e copertura color tortora

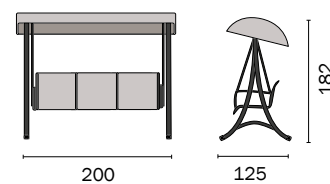

Art. SV 117
 Dondolo 3 posti
 Tubo in ferro Ø 48 mm antracite
 Seduta in textilene nero
 con copertura color grigia



DONDOLI

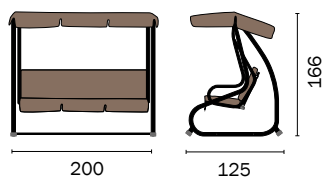

Art. SV 114
 Dondolo 3 posti reclinabile
 Tubo in ferro Ø 48 mm antracite
 Seduta e copertura in poliestere
 160 gr. color tortora

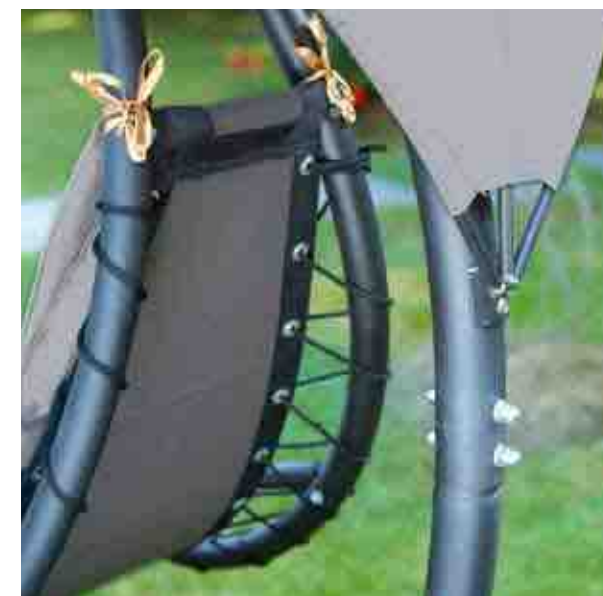
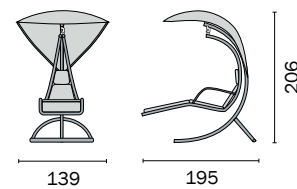

Art. SV 120
 Lettino Foglia con supporto
 Struttura in ferro antracite
 Poliestere imbottito color tortora

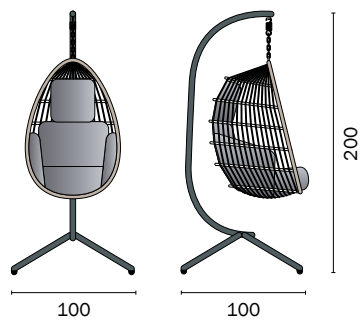







Art. CLW 42
 Poltrona sospesa YO-YO
 Poltrona pieghevole in wicker color avana
 e corda color antracite
 Supporto in metallo color antracite



moia

COVER

Con le coperture in tessuto impermeabile e antistrappo Greenwood i mobili da giardino sono al riparo dagli agenti atmosferici. Le prese d'aria e i distanziali garantiscono l'aerazione dei mobili per eliminare l'umidità interna.

ARTICOLO	DESCRIZIONE	DIMENSIONI
	CVT 01 Cover per tavolo in poliestere impermeabile ed extra-resistente Prese d'aria e distanziale	fino a 180 cm x 110 cm
	CVT 02 Cover per tavolo in poliestere impermeabile ed extra-resistente Prese d'aria e distanziale	fino a 240 cm x 130 cm
	CVL 03 Cover per lettino in poliestere impermeabile ed extra-resistente Prese d'aria	fino a 200 cm x 75 cm
	CVP 04 Cover per poltrona in poliestere impermeabile ed extra-resistente Prese d'aria	fino a 90 cm x 80 cm
	CVD 05 Cover per divano a 2 posti in poliestere impermeabile ed extra-resistente Prese d'aria	fino a 160 cm x 80 cm
	CVD 06 Cover per divano a 3 posti in poliestere impermeabile ed extra-resistente Prese d'aria	fino a 220 cm x 80 cm



MOBILI IN LEGNO DI ACACIA

Realizzati in legno di acacia orientale, certificato dalla normativa FSC, sono particolarmente robusti e resistenti alle intemperie. Necessitano di una manutenzione est remamente ridotta. Costituiscono la soluzione ideale per l'outdoor.



Da sempre attenti al rispetto dell'ambiente e allo sfruttamento responsabile delle riserve naturali Greenwood lancia una collezione di mobili in acacia interamente realizzati in legname con certificato FSC. FSC è l'ente certificatore internazionale che identifica i prodotti realizzati in legno proveniente da foreste gestite in maniera corretta e responsabile, secondo rigorosi standard ambientali, sociali ed economici. Con l'acacia FSC il tuo giardino diventa ancora più verde!

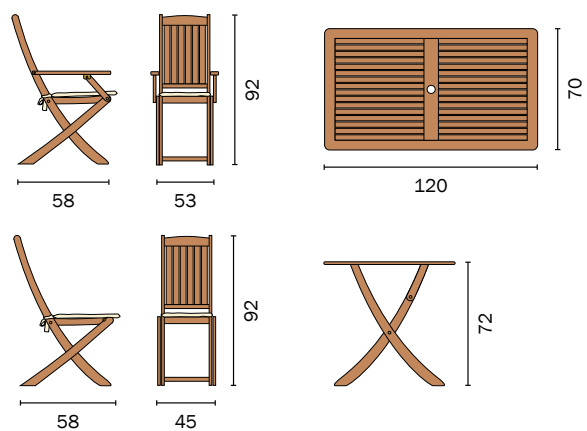

Art. FTA 310
Tavolo Cordova rettangolare pieghevole
Art. CHA 300
Sedia Siviglia senza braccioli

Art. CHA 301
Sedia Siviglia con braccioli
Art. CS 30
Cuscini ecrù sfoderabili
Venduti separatamente



LEGNO DI ACACIA

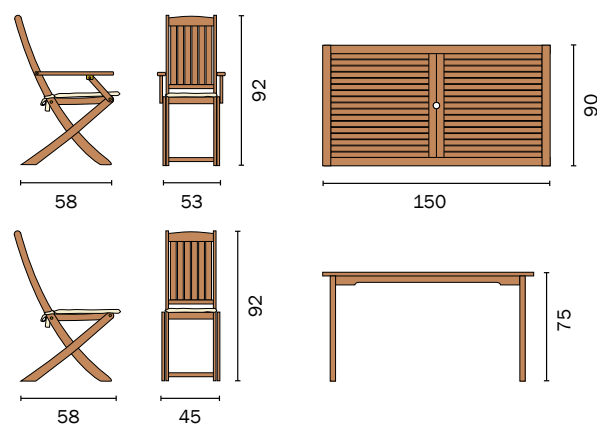

Art. RTA 311
 Tavolo Granada rettangolare
Art. CHA 300
 Sedia Siviglia senza braccioli
Art. CHA 301
 Sedia Siviglia con braccioli
Art. CS 30
 Cuscini ecrù sfoderabili
 Venduti separatamente



Greenwood®



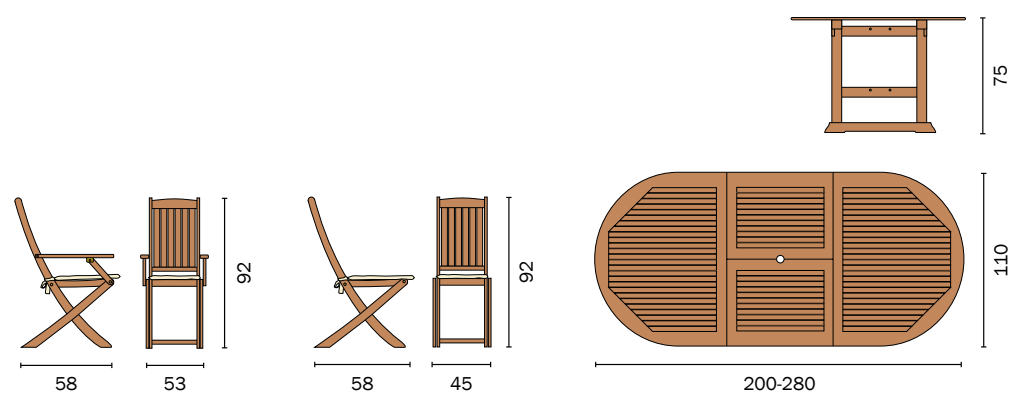

LEGNO DI ACACIA
 FSC

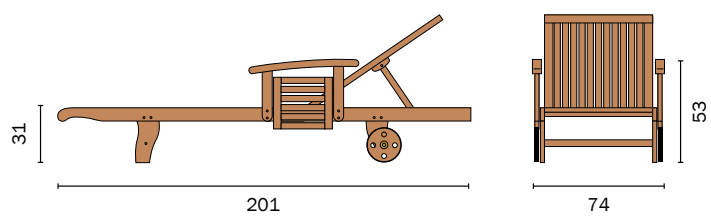

Art. OTA 312
 Tavolo ovale Malaga allungabile
Art. CHA 300
 Sedia Siviglia senza braccioli
Art. CHA 301
 Sedia Siviglia con braccioli
Art. CS 30
 Cuscini ecrù sfoderabili
 Venduti separatamente

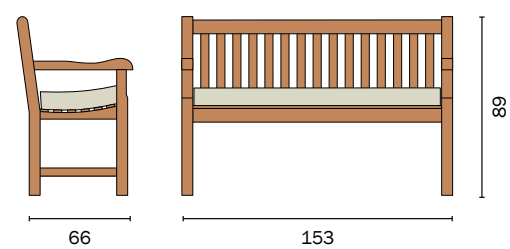

Art. CLA 321
 Lettino Marbella
Art. CS 32
 Cuscino ecrù sfoderabile
 Venduto separatamente



Art. BEA 323
 Panca tre posti Siviglia
Art. CS 31
 Cuscino ecrù sfoderabile
 Venduto separatamente



Greenwood[®]



moia 

ACACIA ANTICATA

L'effetto anticato impreziosisce questa collezione in acacia dandole un sapore coloniale.



ACACIA OLIATA

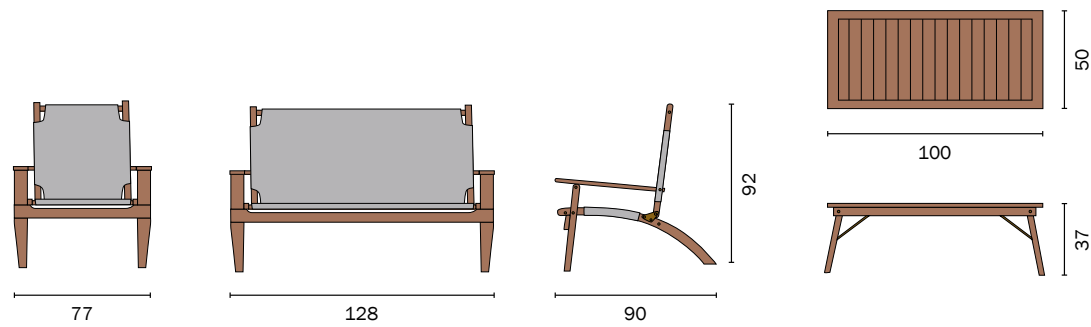

Art. CSA 13S
Set Valladolid pieghevole
Policotone 350 gr color sabbia

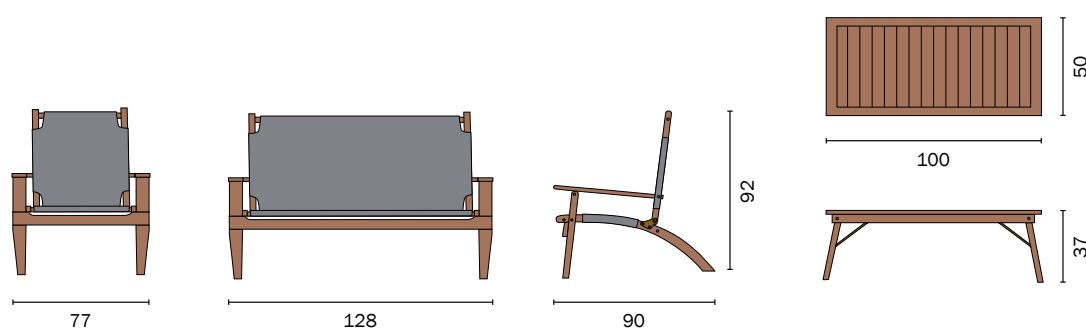

Art. CSA 13G
 Set Valladolid pieghevole
 Policotone 350 gr color grigio antracite



ACACIA ANTICATA

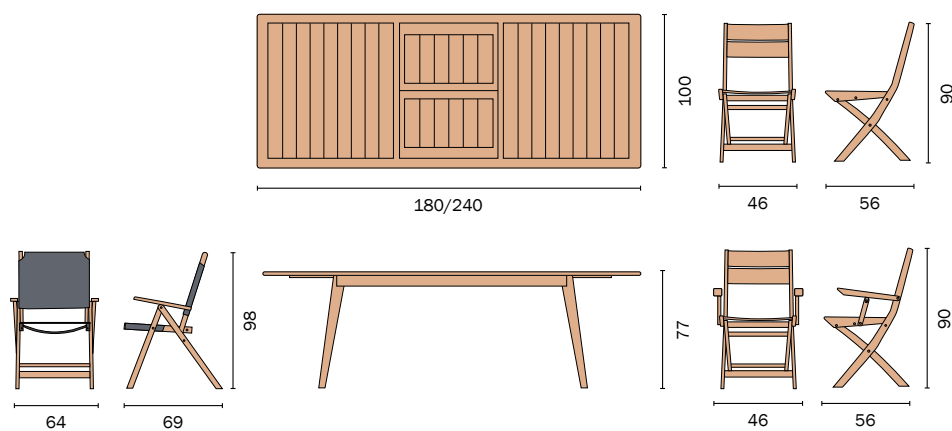

Art. RTA 313
Tavolo Valladolid allungabile
Art. CHA 304
Sedia Valladolid pieghevole
Seduta e schienale in policotone 350 gr
color grigio antracite
Art. CHA 303
Sedia Leon pieghevole



MOBILI IN LEGNO DI TEAK

I vantaggi del Teak, legno tropicale noto per le sue caratteristiche di resistenza e durevolezza e un'estetica moderna e funzionale, danno origine a questa serie di mobili ideali per l'outdoor.



L'attenzione di Greenwood per la natura e per un utilizzo sostenibile delle sue risorse è dimostrato dalla scelta di prediligere partner che possiedono specifici requisiti di certificazione nell'ambito dello sfruttamento responsabile delle foreste. In quest'ottica l'azienda ha selezionato una collezione di mobili in teak con certificazione internazionale Mutu. Mutu è attivo nel campo delle certificazioni forestali fin dal 1990. In particolare è specializzato nella valutazione delle foreste di teak indonesiano, paese in cui ha appunto la sede principale.



Art. RT 512
Tavolo Vulcano quadrato pieghevole
Art. CH 503
Sedia Panarea
Art. CS 52
Cuscini sfoderabili solo seduta verde salvia

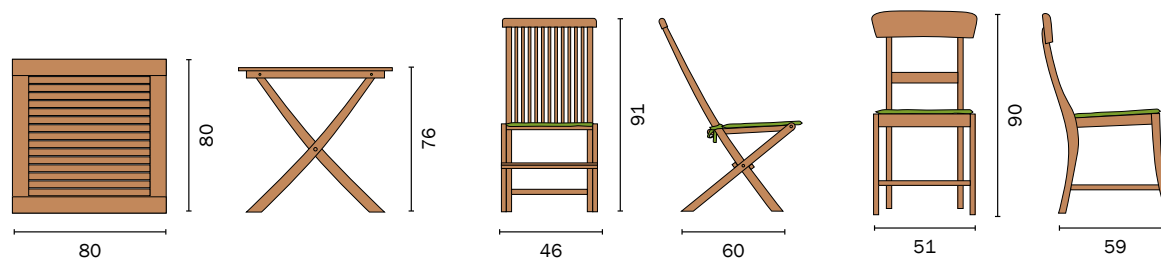

Art. RT 512
Tavolo Vulcano quadrato pieghevole
Art. CH 501
Sedia Salina pieghevole
Art. CS 51E
Cuscini sfoderabili seduta e schienale ecrù
Art. CS 52
Cuscini sfoderabili solo seduta verde salvia



LEGNO DI TEAK

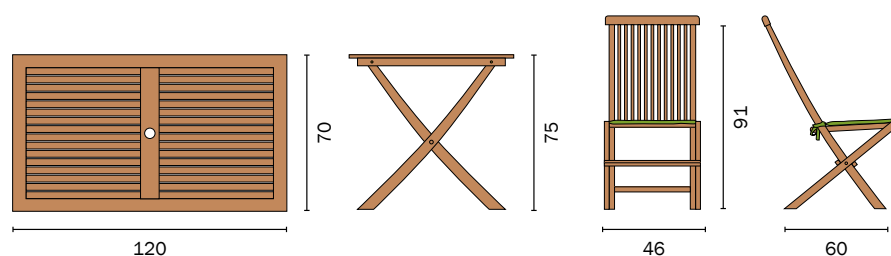

Art. RT 504
Tavolo Lipari rettangolare pieghevole

Art. CH 501
Sedia Salina pieghevole

Art. CS 51E
Cuscini sfoderabili seduta e schienale ecrù

Art. CS 52
Cuscini sfoderabili
solo seduta verde salvia



Greenwood[®]



Art. RT 508
Tavolo Filicudi rettangolare
Art. CH 503
Sedia Panarea
Art. CS 52
Cuscini sfoderabili solo seduta verde salvia

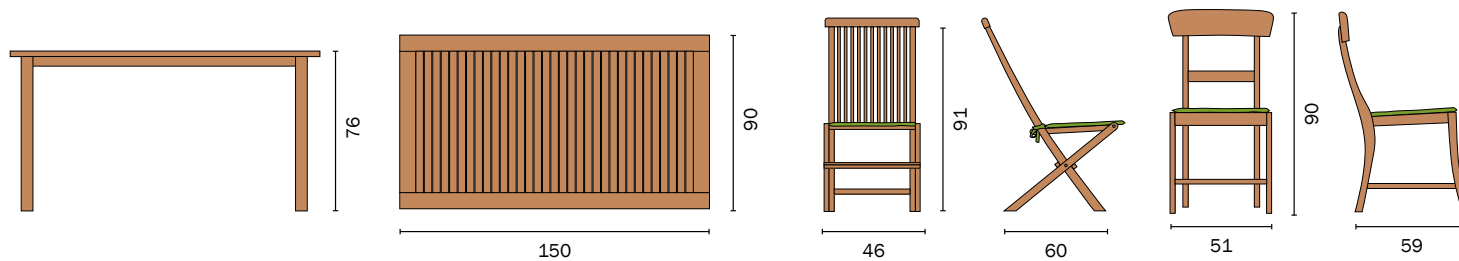

LEGNO DI TEAK



Art. RT 508
Tavolo Filicudi rettangolare
Art. CH 501
Sedia Salina pieghevole
Art. CS 51E
Cuscini sfoderabili seduta e schienale ecru
Art. CS 52
Cuscini sfoderabili solo seduta verde salvia

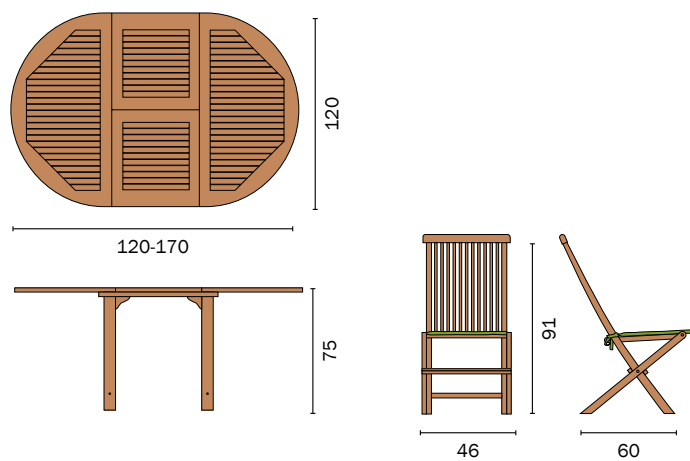

Art. RT 507
Tavolo Capraia tondo allungabile 8 posti
Art. CH 501
Sedia Salina pieghevole



Art. CS 51
Cuscini sfoderabili seduta e schienale ecrù
Art. CS 52
Cuscini sfoderabili solo seduta verde salvia



LEGNO DI TEAK

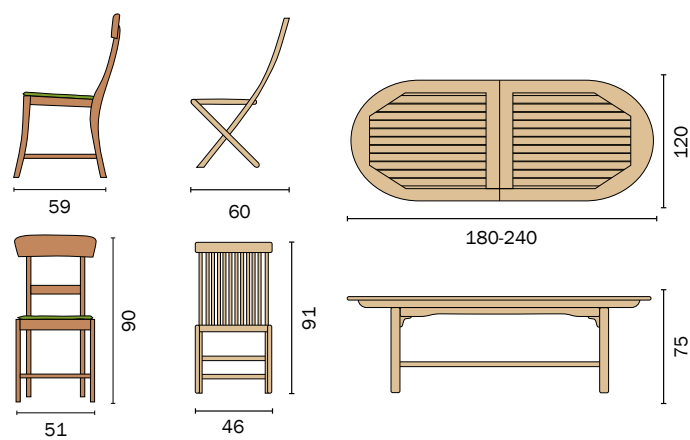

Art. CH 503
Sedia Panarea



Art. OT 503
Tavolo ovale Alicudi allungabile

Art. CH 501
Sedia Salina pieghevole

Art. CS 51
Cuscini sfoderabili seduta e schienale ecru

Art. CS 52
Cuscini sfoderabili solo seduta verde salvia

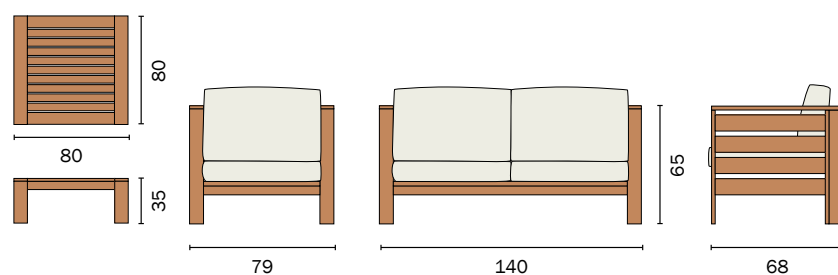

Art. CST 01
Coffee Set Stromboli
Cuscini sfoderabili ecrù



LEGNO DI TEAK



Art. CL 511
Lettino Carloforte con tavolino
estraibile - con ruote
Art. CS 55
Cuscino sfoderabile ecru
Venduto separatamente

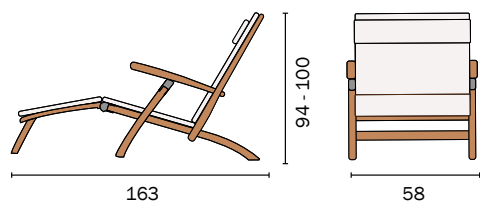
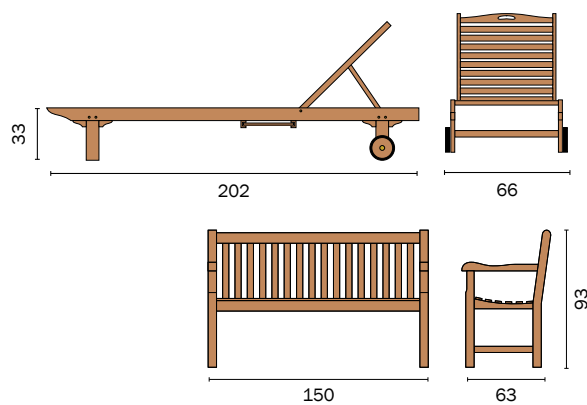

Art. ST 506
Poltrona Steamer con cuscino
ecru sfoderabile



Art. BE 510
Panca 3 posti Lampedusa
Art. CS 54
Cuscino sfoderabile ecru
Venduto separatamente



TAVOLI MAXI IN TEAK

I tavoli Maxi sono realizzati nella pregiata essenza del teak.
Alcuni di questi sono realizzati in legno riciclato: una soluzione
ecologica e particolarmente apprezzata per la qualità del legno a
cui viene data nuova vita nei nostri giardini.



LEGNO DI TEAK

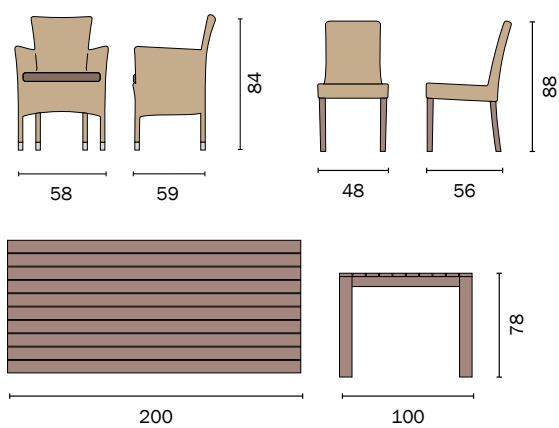

Art. WRT 03S
Tavolo Bali
Legno Teak scurito

Art. CHW 10
Poltroncina Tindari impilabile
con cuscino color tortora
Wicker spazzolato 7 mm

Art. RCH 23
Sedia Lisbona
Fibra in Grey Kubu

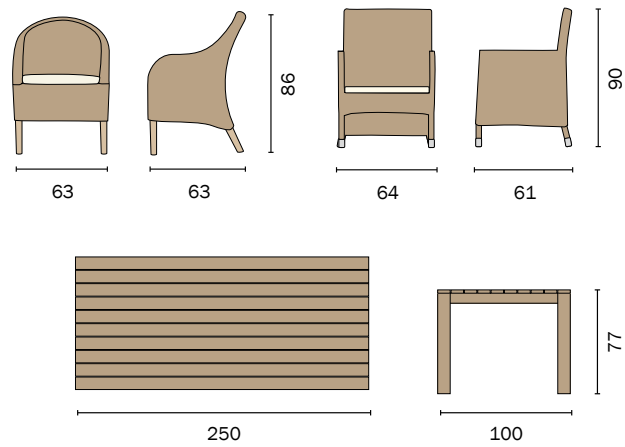

Art. CHW 60
 Poltroncina Antigua
 Wicker Ø 5 mm color Grey Kubu
 Cuscini color grigio sfoderabili

Art. WRT 04
 Tavolo Papua
 Legno Teak riciclato
Art. RCH 24
 Poltroncina Algarve
 Fibra in Kubu naturale
 Cuscini color ecru sfoderabili



LEGNO DI TEAK

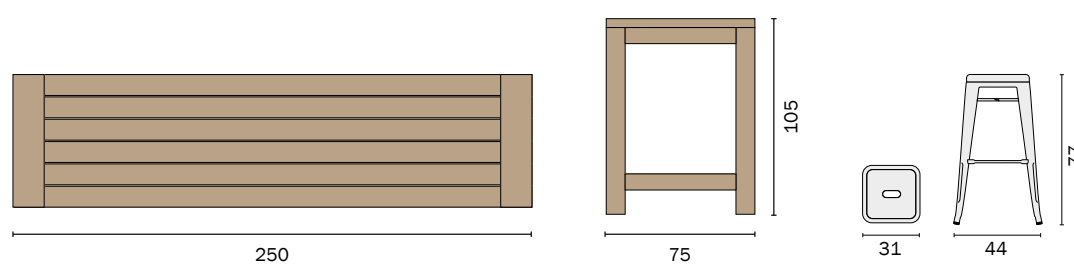

Art. WRT 05
 Bancone Java
 Legno teak riciclato
Art. BS 10G
 Sgabello in lamiera galvanizzata
 Impilabile - Color silver



moia 

MOBILI IN TEAK E ALLUMINIO

In questa serie di mobili il calore del teak si accompagna alla nuova finitura nera dell'alluminio, trattato con speciale vernice epossidica per creare un elegante contrasto che sfocia in una soluzione estetica ricca di personalità.



LEGNO DI TEAK
E ALLUMINIO COLOR NERO

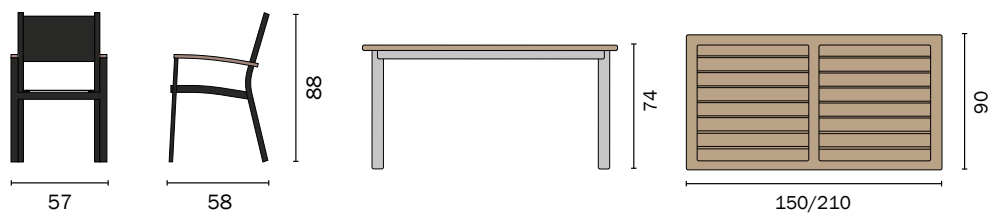

Art. RTT 62
Tavolo Vigo allungabile
Art. CHT 54
Sedia Formentera impilabile
con seduta in textilene nero imbottito e
braccioni in teak

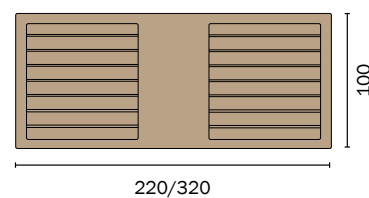
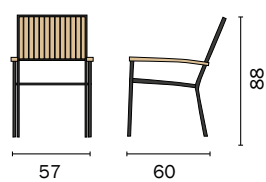

Art. RTT 64
 Tavolo Alicante allungabile
Art. CHT 52
 Sedia Ibiza impilabile
Art. CS 68
 Cuscino sfoderabile ecrù
 Venduto separatamente



LEGNO DI TEAK
E ALLUMINIO COLOR NERO

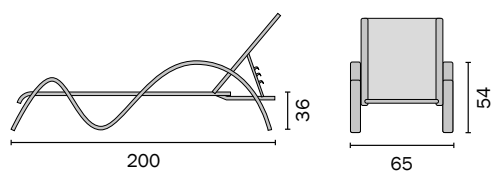

Art. CLT 73
Lettino Onda impilabile in textilene



LEGNO DI TEAK
E ALLUMINIO COLOR AVORIO

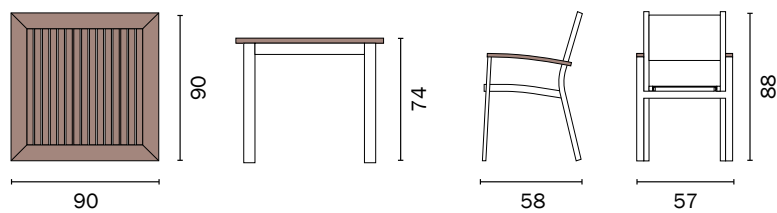

Art. RTT 81
Tavolo Calvi quadrato
Art. CHT 80
Sedia Bastia impilabile con seduta in
textilene imbottito e braccioli in teak

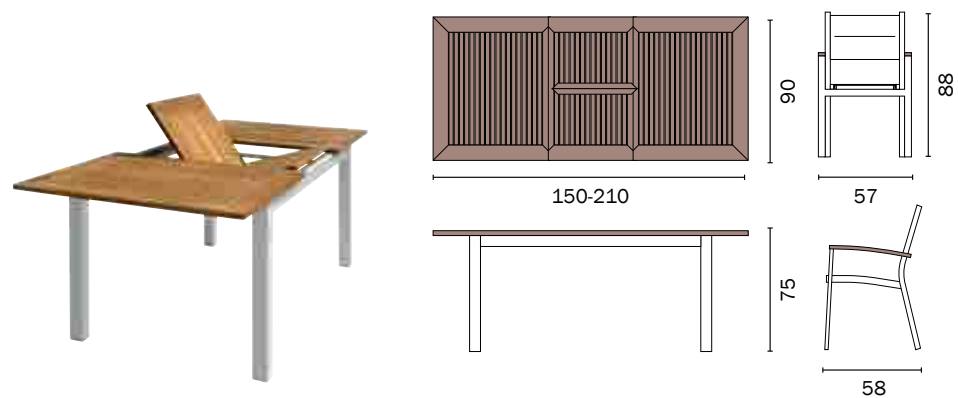

Greenwood®



Art. RTT 82
Tavolo Ajaccio allungabile
Art. CHT 80
Sedia Bastia impilabile con seduta
in textilene imbottito e braccioli in teak

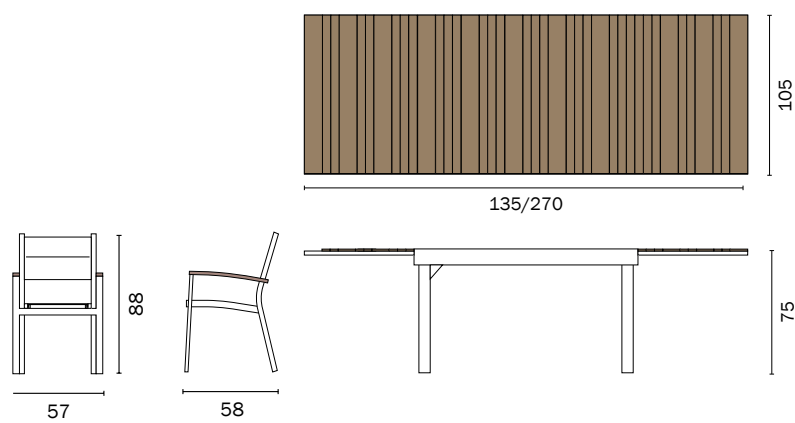

LEGNO DI TEAK
E ALLUMINIO COLOR AVORIO



Art. RTT 84
Tavolo Bonifacio allungabile
Art. CHT 80
Sedia Bastia impilabile con seduta
in textilene imbottita e braccioli in teak



ALLUMINIO COLOR AVORIO

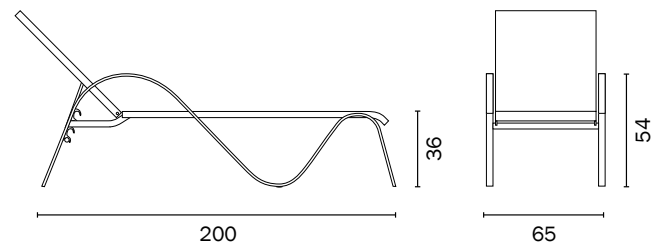

Art. CLT 83
 Lettino Porto Vecchio impilabile in alluminio
 e textilene avorio



MOBILI IN RESIN WOOD

Eleganti e funzionali, sono realizzati con l'impiego di un nuovo materiale che non fa rimpiangere il legno. I piani in RESIN WOOD infatti sono leggeri, di grande effetto estetico e non richiedono manutenzione. La struttura in alluminio inoltre ne esalta ulteriormente le qualità di durata nel tempo, praticità e solidità.



RESIN WOOD CON
STRUTTURA IN ALLUMINIO
GRIGIO ANTRACITE

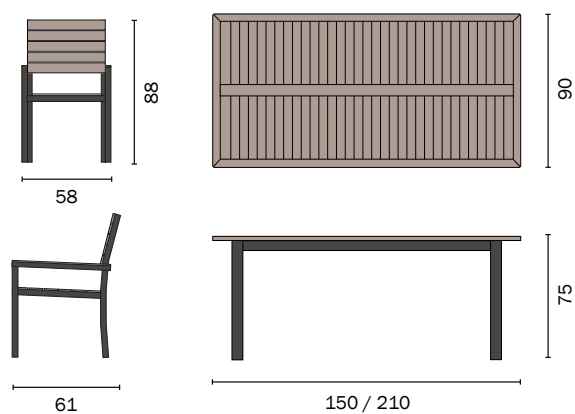

Art. RTE 54A
Tavolo Riomaggiore allungabile
Piano in resin wood grigio
con trattamento impermeabile



Art. CHE 35A
Sedia Deiva impilabile
Seduta e schienale in resin wood grigio
con trattamento impermeabile
Art. CS 68
Cuscino sfoderabile ecrù
venduto separatamente

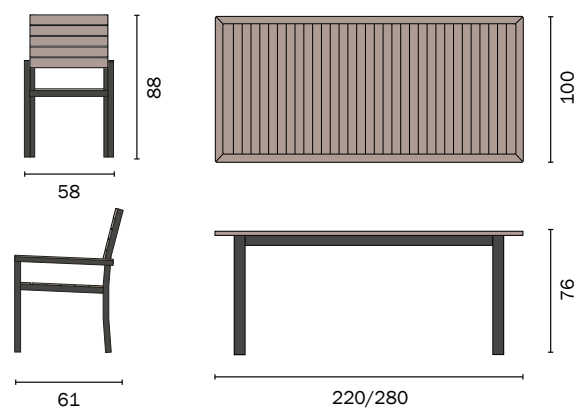

Art. RTE 51A
Tavolo Monterosso allungabile
Piano in resin wood grigio
con trattamento impermeabile

Art. CHE 35A
Sedia Deiva impilabile
Seduta e schienale in resin wood grigio
con trattamento impermeabile

Art. CS 68
Cuscino sfoderabile ecrù
venduto separatamente



RESIN WOOD CON
STRUTTURA IN ALLUMINIO
BIANCO

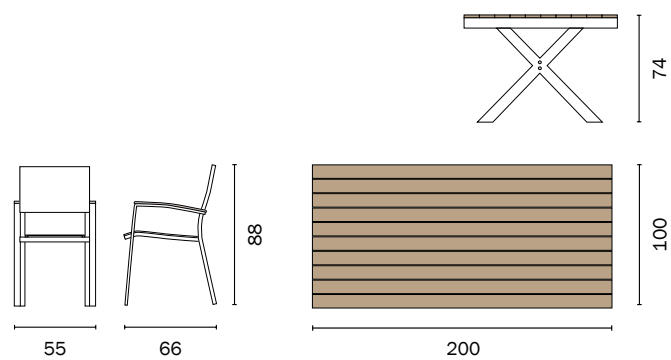

Art. RTE 58
Tavolo Baratti
Piano in resin wood color teak

Art. CHE 36
Sedia Popolonia impilabile
Seduta e schienale in textilene bianco
Braccioli in resin wood color teak



RESIN WOOD CON
STRUTTURA IN ALLUMINIO
SATINATO

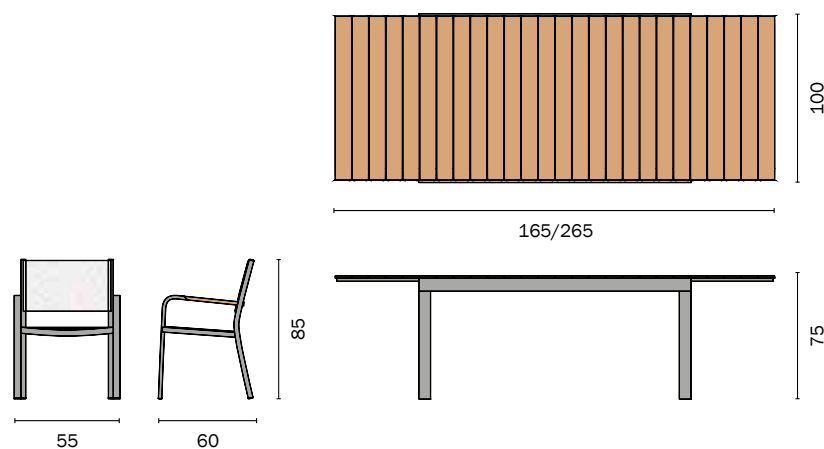

Art. RTE 59
Tavolo Cortina allungabile
Piano in resin wood color teak

Art. CHE 37
Sedia Cortina impilabile
con braccioli in resin wood color teak
Textilene tortora

Greenwood®



RESIN WOOD CON
STRUTTURA IN ALLUMINIO
SATINATO

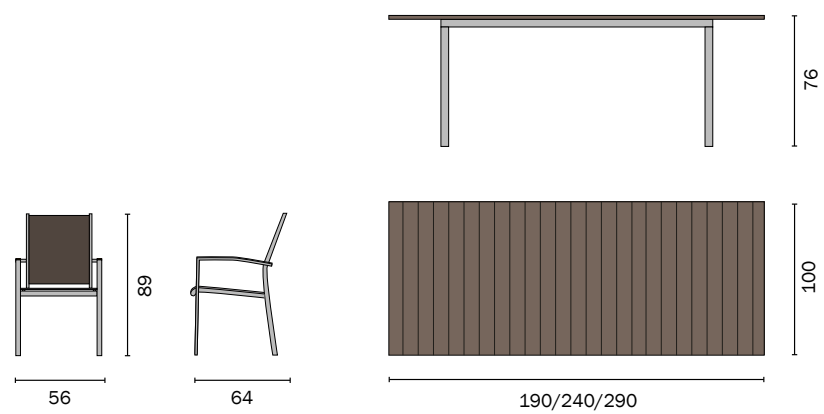

Art. RTE 57
Tavolo Saint Moritz con doppio allungo
Piano in resin wood color castagno



Art. CHE 34
Sedia Saint Moritz impilabile
con seduta in textilene grigio scuro
e braccioli in resin wood colore castagno



moia 

MOBILI IN FERRO

Linee sobrie ed armoniose caratterizzano questa collezione. Realizzati in ferro trattato contro la ruggine con zincatura galvanica o con prodotti specifici, essi vengono verniciati a forno con vernici epossidiche termoindurenti.



MOBILI IN FERRO
COLOR GRIGIO
ANTRACITE

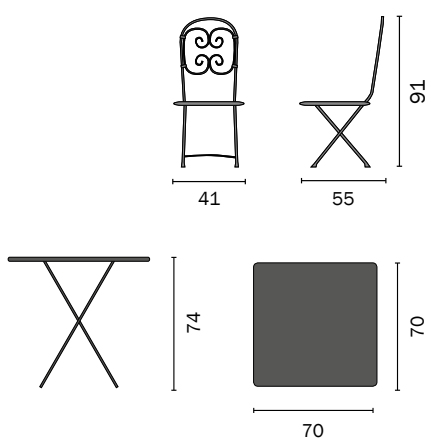

Art. FTF 57
Tavolo Orta pieghevole 70 x 70 cm
Art. CHF 08
Sedia pieghevole Orta
Art. CS 14
Cuscino ecrù venduto separatamente

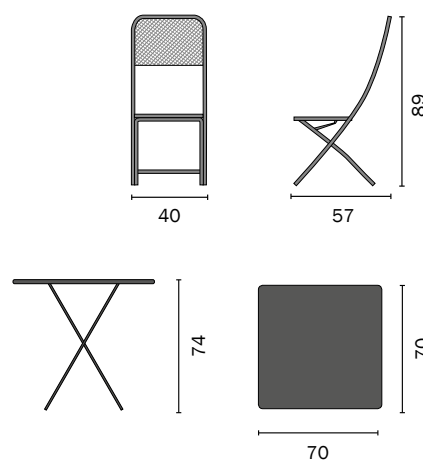

Art. FTF 57
Tavolo Orta pieghevole 70 x 70 cm
Art. CHF 71
Sedia Ispra pieghevole disegno a rombi
Art. CS 71
Cuscino ecrù venduto separatamente

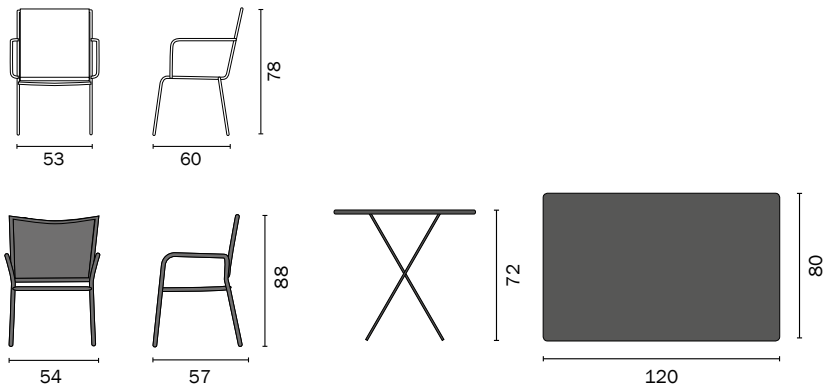

Art. FTF 58
Tavolo Orta pieghevole 120 x 80 cm

Art. CC 47M
Sedia Spaghetti in ferro con braccioli impilabile
con telaio antracite e filo marrone

Art. CHF 21
Sedia Lavano traforata impilabile
Art. CS 44
Cuscino ecrù venduto separatamente

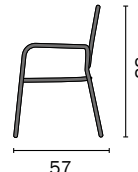
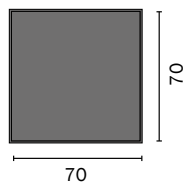
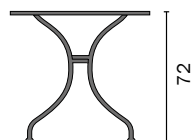
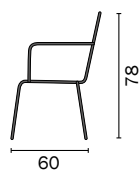
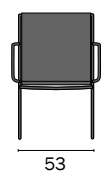

Art. CC 47M
Sedia Spaghetti in ferro con braccioli impilabile
con telaio antracite e filo marrone

Art. STF 21
Tavolo Cannero 70 x 70 cm disegno rete
Art. CHF 21
Sedia Laveno traforata impilabile
Art. CS 44
Cuscino ecrù venduto separatamente



**MOBILI IN FERRO
COLOR GRIGIO ANTRACITE**

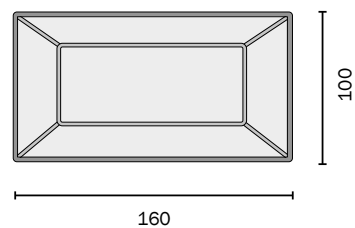
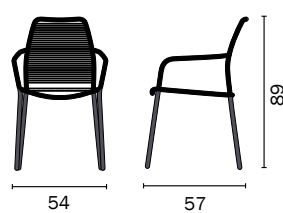
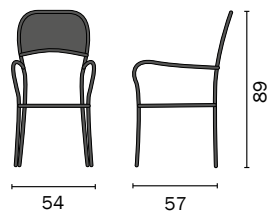

Art. CHF 68

Sedia Intra impilabile con braccioli
disegno a rombi

Art. CS 44

Cuscino ecrù venduto separatamente

Art. RTF 23

Tavolo Ameno disegno rete

Art. CHF 09

Sedia Buccione impilabile con braccioli
corda color grigio antracite

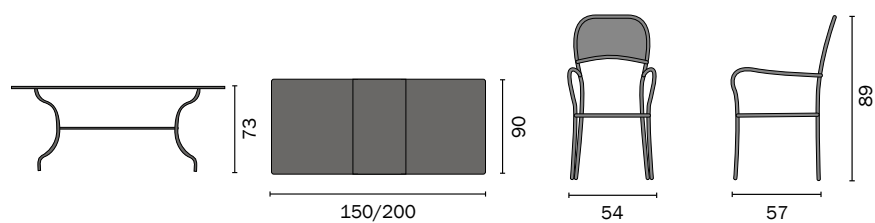

- Art. ETF 67**
Tavolo Ginevra allungabile 150/200 cm
- Art. CHF 68**
Sedia Intra impilabile con braccioli
disegno a rombi
- Art. CS 44**
Cuscino ecrù venduto separatamente



MOBILI IN FERRO
COLOR GRIGIO ANTRACITE

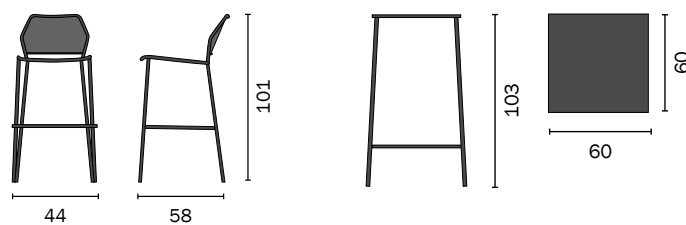

Art. BTF 75
Tavolo alto Angera 60 x 60 cm
Art. BSF 74
Sgabello alto Angera impilabile traforato

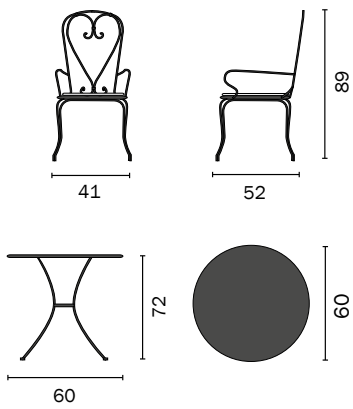

Art. TTF 51
Tavolo Stresa Ø 60 cm
Art. CHF 04
Sedia Stresa con braccioli impilabile
Art. CS 14
Cuscino ecru venduto separatamente

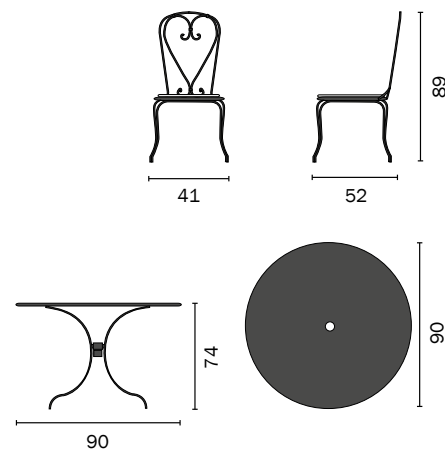

Art. TTF 52
Tavolo Baveno Ø 90 cm
Art. CHF 03
Sedia Stresa senza braccioli impilabile
Art. CS 14
Cuscino ecru venduto separatamente



MOBILI IN FERRO
COLOR NERO

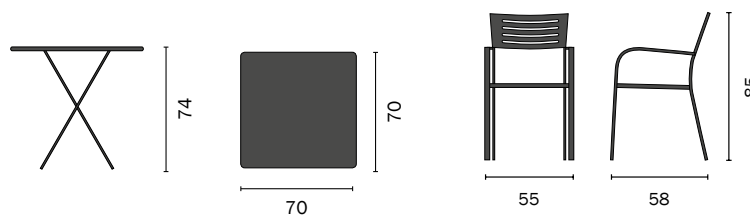

Art. FTF 59

Tavolo Stresa 70 x 70 cm pieghevole

Art. CHF 16N

Sedia Taormina con braccioli impilabile

Art. CS 44

Cuscino ecru venduto separatamente

Greenwood®

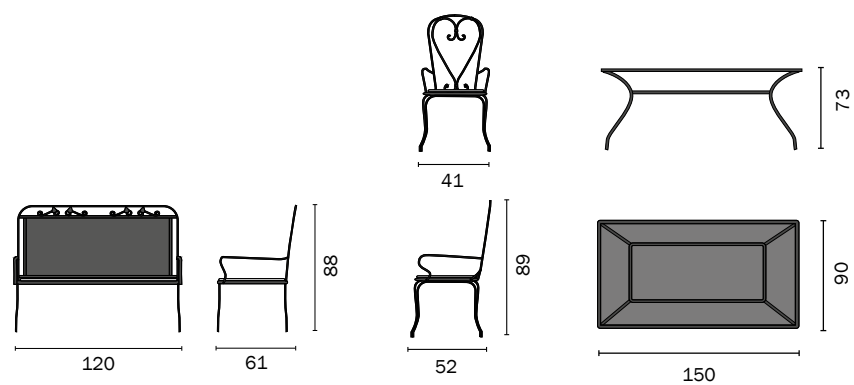

Art. BEF 10
Panca Verbania impilabile
Art. CS 47
Cuscino ecrù venduto separatamente



Art. RTF 53
Tavolo Cannobio 150 x 90 cm
Art. CHF 04
Sedia Stresa con braccioli impilabile
Art. CS 14
Cuscino ecrù venduto separatamente



MOBILI IN FERRO
COLOR NERO

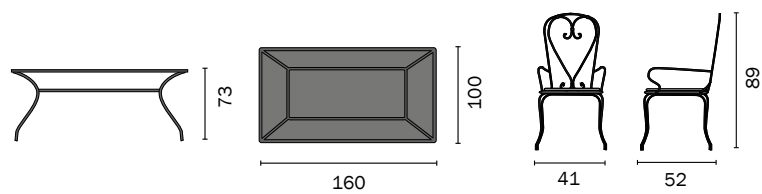

Art. RTF 61
Tavolo Ticino 160 x 100 cm

Art. CHF 04
Sedia Stresa con braccioli impilabile

Art. CS 14
Cuscino ecru venduto separatamente

Greenwood®



MOBILI IN FERRO
COLOR NERO

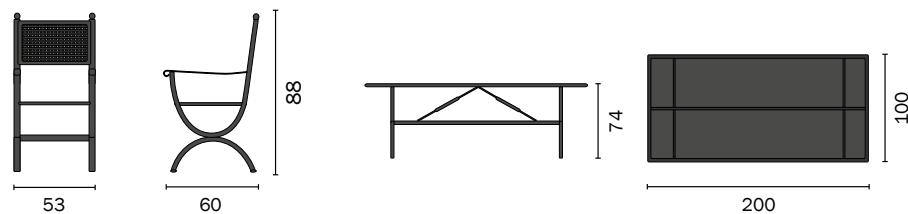

Art. RTF 65
Tavolo Lugano 200 x 100 cm
Art. CHF 66
Sedia Lugano
con cuscino sfoderabile ecrù



MOBILI IN FERRO NERO
CON MOSAICO

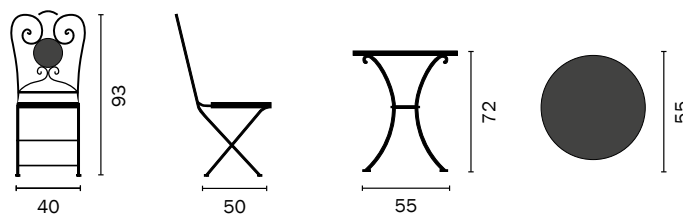

Art. TTM 11
Tavolo Mosaico tondo Ø 55 cm
Art. CHM 02
Sedia Mosaico pieghevole



MOBILI IN FERRO
COLOR NERO

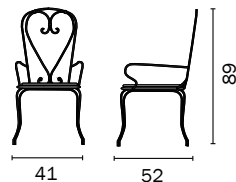
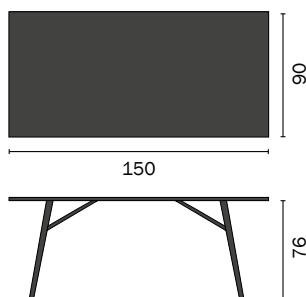
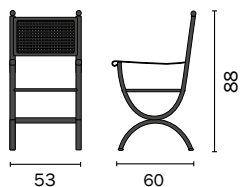

Art. CHF 66
Sedia Lugano
con cuscino sfoderabile ecru

Art. TTM 12
Tavolo Mosaico 150 x 90 cm
Art. CHF 66
Sedia Lugano
con cuscino sfoderabile ecru

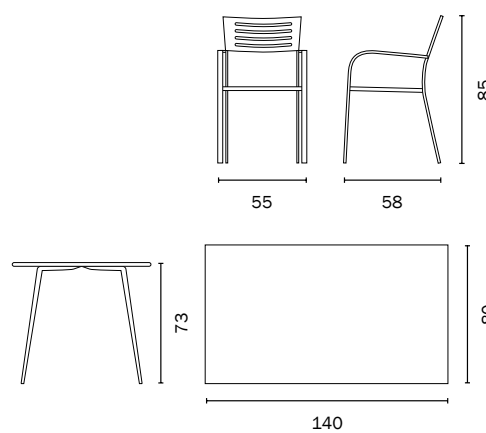
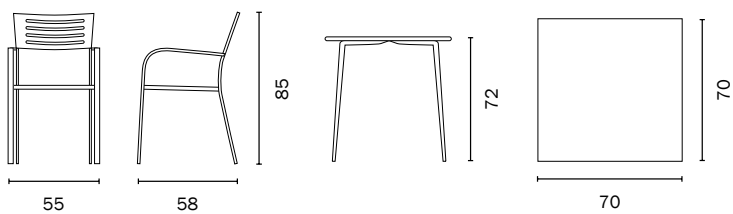

Art. STF 31
Tavolo Messina 70 x 70 cm in ferro bianco

Art. CHF 16
Sedia Taormina con braccioli impilabile
in ferro bianco, azzurro, verdino

Art. CS 44
Cuscino ecrù venduto separatamente

Art. RTF 20
Tavolo Messina 140 x 80 cm in ferro bianco

Art. CHF 16
Sedia Taormina con braccioli impilabile
in ferro bianco, azzurro, verdino

Art. CS 44
Cuscino ecrù venduto separatamente



MOBILI IN FERRO
COLOR BIANCO

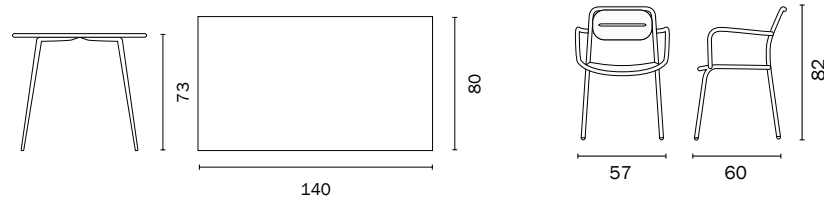

Art. RTF 20
Tavolo Messina 140 x 80 cm
Art. CHF 82
Sedia Augusta con braccioli impilabile
Art. CS 44
Cuscino ecru venduto separatamente

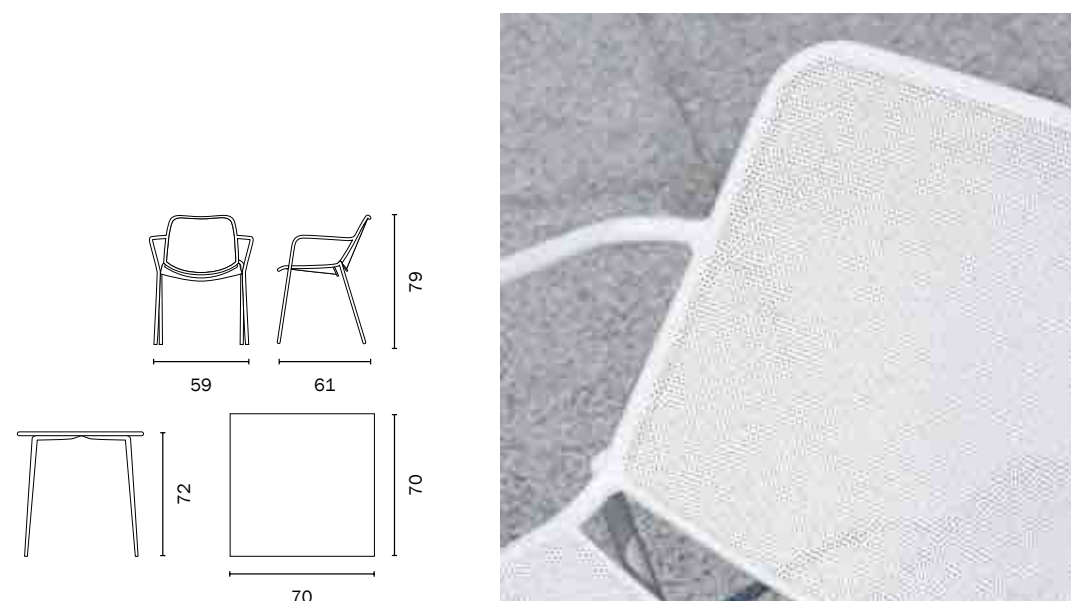

Art. STF 31
Tavolo Messina 70 x 70 cm
Art. CHF 83
Sedia Licata impilabile
microforata
Art. CS 83
Cuscino bianco venduto separatamente

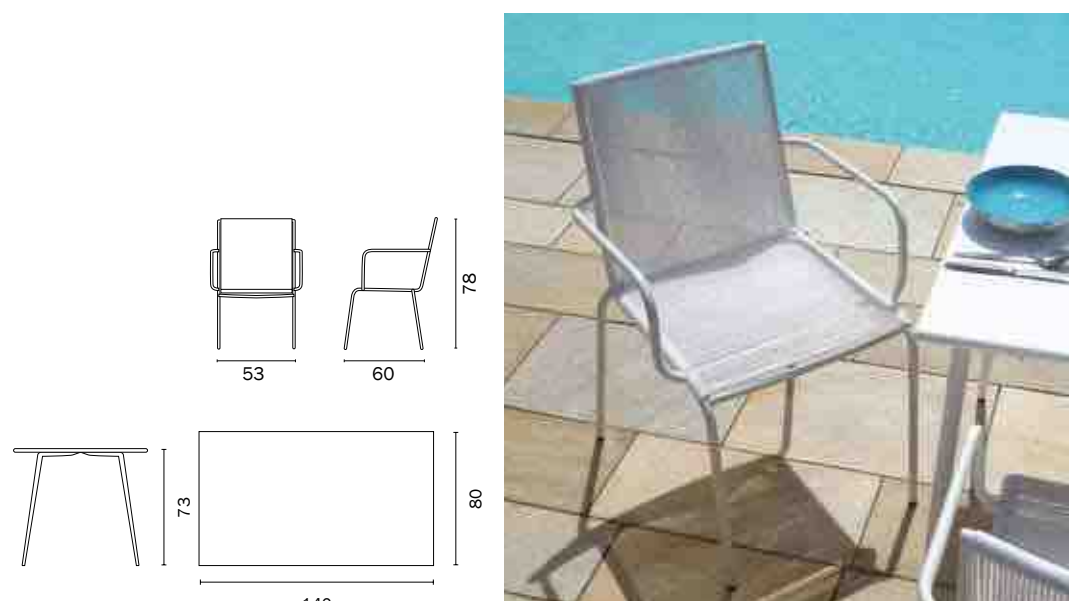

Art. RTF 20
Tavolo Messina 140 x 80 cm
Art. CC 47B
Sedia Spaghetti in ferro con braccioli impilabile
telaio bianco e filo bianco



**MOBILI IN FERRO
COLOR AVORIO**

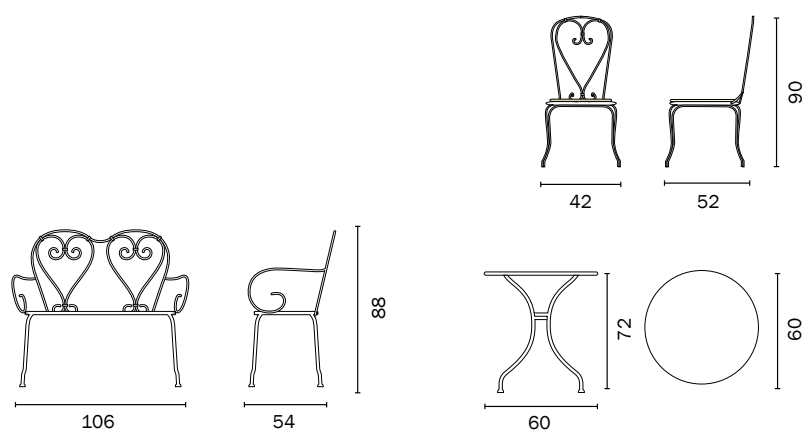

Art. BEF 85
Panca Sirmione
Art. CS 85
Cuscino ecrù venduto separatamente



Art. TTF 82
Tavolo Peschiera tondo Ø 60 cm
Art. CHF 80
Sedia Sirmione senza braccioli impilabile
Art. CS 14
Cuscino ecrù venduto separatamente

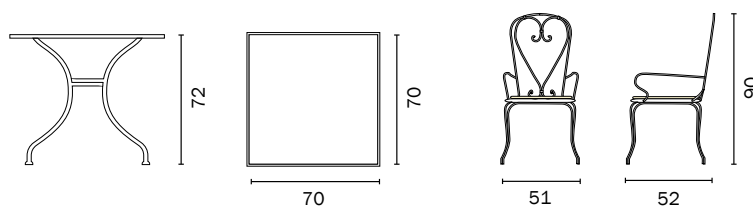

Art. STF 21A
Tavolo Bardolino 70 x 70 cm disegno rete
Art. CHF 81
Sedia Sirmione con braccioli impilabile
Art. CS 14
Cuscino ecru venduto separatamente



**MOBILI IN FERRO
COLOR AVORIO**



Art. CHF 80
Sedia Sirmione senza
braccioli impilabile

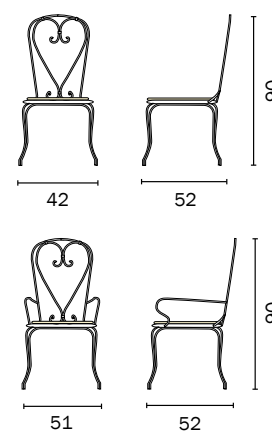
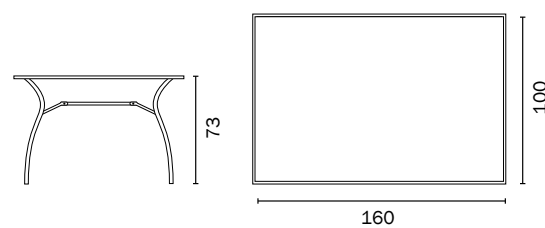

Art. RTF 84

Tavolo Desenzano 160 x 100 cm
disegno rete











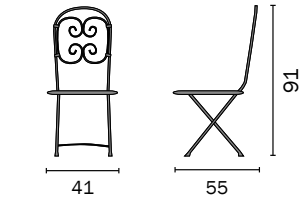

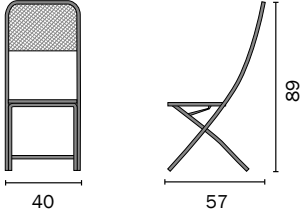
Art. CHF 81

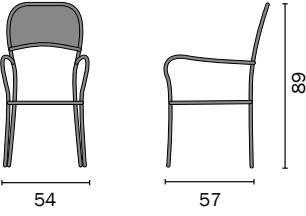
Sedia Sirmione senza braccioli impilabile

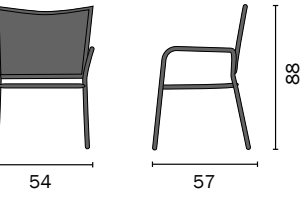
Art. CS 14

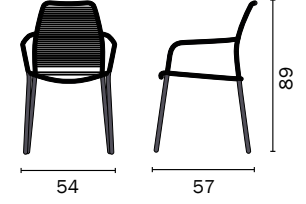

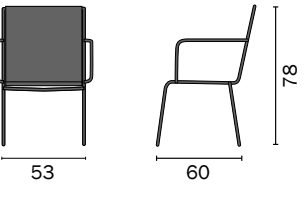

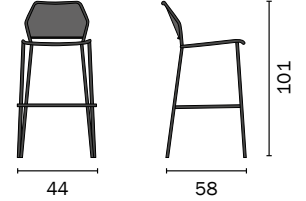



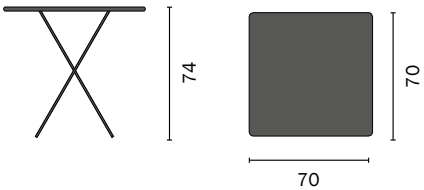

Cuscino ecru venduto separatamente

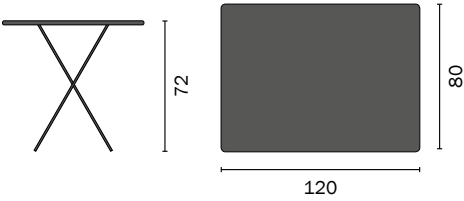
MOBILI IN FERRO COLOR GRIGIO ANTRACITE

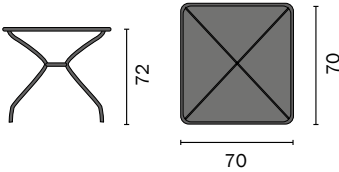

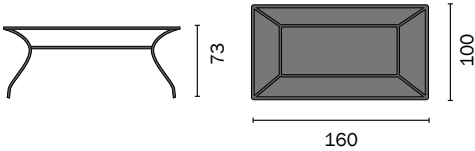

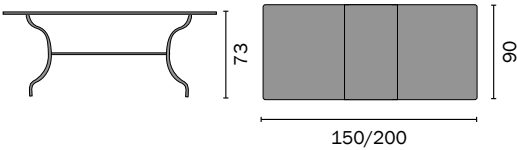

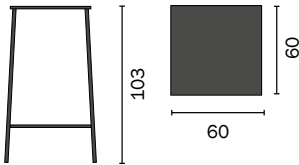

ARTICOLO	DESCRIZIONE	DIMENSIONI	DISEGNO TECNICO
	CHF 08 Sedia Orta pieghevole Cuscino ecrù (Art. CS 14) venduto separatamente	Base 41 Altezza 91 Profondità 55	
	CHF 71 Sedia Ispra pieghevole Cuscino ecrù (Art. CS 71) venduto separatamente	Base 40 Altezza 89 Profondità 57	
	CHF 68 Sedia Intra impilabile Cuscino ecrù (Art. CS 44) venduto separatamente	Base 54 Altezza 89 Profondità 57	
	CHF 21 Sedia Laveno impilabile Cuscino ecrù (Art. CS 44) venduto separatamente	Base 54 Altezza 88 Profondità 57	
	CHF 09 Sedia Buccione impilabile con braccioli corda color grigio antracite	Base 54 Altezza 89 Profondità 57	
	CC 47M Sedia Spaghetti impilabile	Base 53 Altezza 78 Profondità 60	
	BSF 74 Sgabello alto impilabile con schienale Angera	Base 44 Altezza 101 Profondità 58	

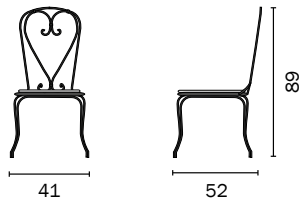
- CS 14** Cuscino sedia Orta
CS 44 Cuscino sedia Intra e Laveno
CS 71 Cuscino sedia Ispra

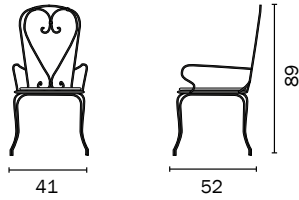

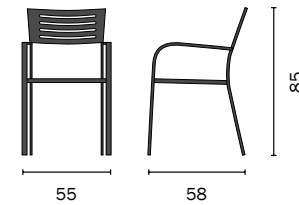

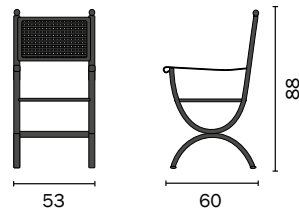
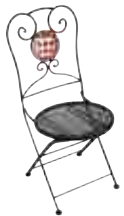
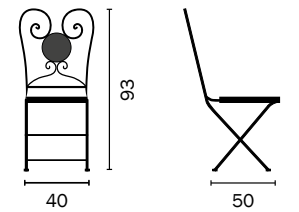

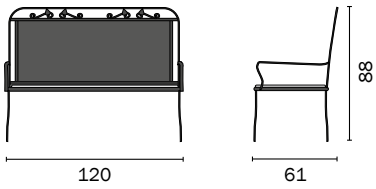



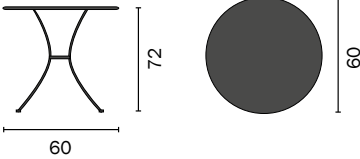

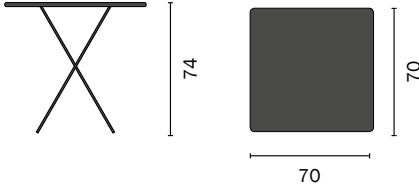

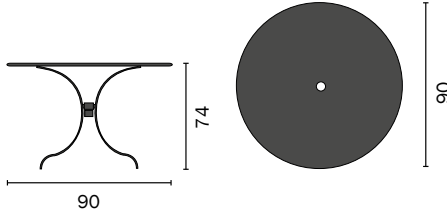
MOBILI IN FERRO COLOR GRIGIO ANTRACITE

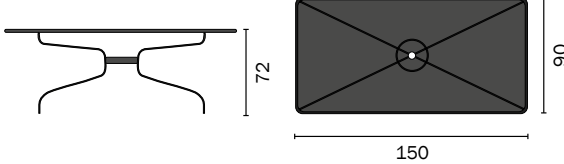
ARTICOLO	DESCRIZIONE	DIMENSIONI	DISEGNO TECNICO
	FTF 57 Tavolo Orta 70 x 70 cm pieghevole	Base 70 Altezza 74 Profondità 70	
	FTF 58 Tavolo Orta 120 x 80 cm pieghevole	Base 120 Altezza 72 Profondità 80	
	STF 21 Tavolo Cannero	Base 70 Altezza 72 Profondità 70	
	RTF 23 Tavolo Ameno	Base 160 Altezza 73 Profondità 100	
	ETF 67 Tavolo Ginevra allungabile	Base 150/200 Altezza 73 Profondità 90	
	BTF 75 Tavolo alto Angera	Base 60 Altezza 103 Profondità 60	

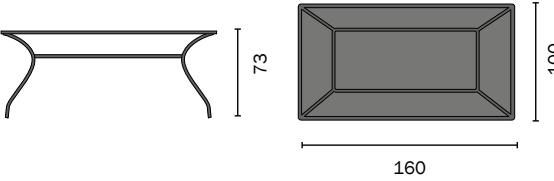

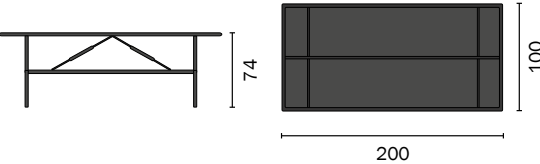
MOBILI IN FERRO COLOR NERO

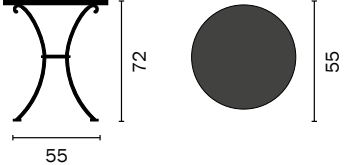
ARTICOLO	DESCRIZIONE	DIMENSIONI	DISEGNO TECNICO
	CHF 03 Sedia Stresa senza braccioli impilabile Cuscino ecrù (Art. CS 14) venduto separatamente	Base 41 Altezza 89 Profondità 52	
	CHF 04 Sedia Stresa con braccioli impilabile Cuscino ecrù (Art. CS 14) venduto separatamente	Base 41 Altezza 89 Profondità 52	
	CHF 16N Sedia Taormina con braccioli impilabile	Base 55 Altezza 85 Profondità 58	
	CHF 66 Sedia Lugano con cuscino ecrù sfoderabile	Base 53 Altezza 88 Profondità 60	
	CHM 02 Sedia Mosaico pieghevole	Base 40 Altezza 93 Profondità 50	
	BEF 10 Panca Verbania impilabile Cuscino ecrù (Art. CS 47) venduto separatamente	Base 120 Altezza 88 Profondità 61	

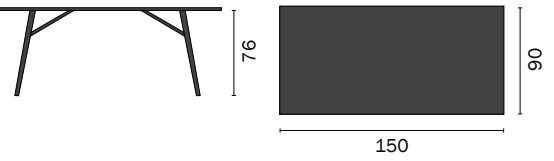
- CS 14 Cuscino sedia Stresa
CS 44 Cuscino sedia Taormina
CS 47 Cuscino panca Verbania

ARTICOLO	DESCRIZIONE	DIMENSIONI	DISEGNO TECNICO
	TTF 51 Tavolo Stresa Ø 60	Base Ø 60 Altezza 72	
	FTF 59 Tavolo Stresa pieghevole 70x70	Base 70 Altezza 74 Profondità 70	
	TTF 52 Tavolo Baveno	Base Ø 90 Altezza 74	
	RTF 53 Tavolo Cannobio	Base 150 Altezza 72 Profondità 90	
	RTF 61 Tavolo Ticino	Base 160 Altezza 73 Profondità 100	
	RTF 65 Tavolo Lugano	Base 200 Altezza 74 Profondità 100	
	TTM 11 Tavolo Mosaico	Base Ø 55 Altezza 72	
	TTM 12 Tavolo Mosaico	Base 150 Altezza 76 Profondità 90	

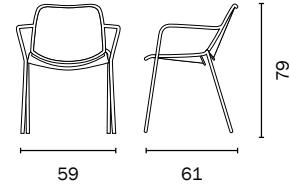
MOBILI IN FERRO COLOR BIANCO

ARTICOLO	DESCRIZIONE	DIMENSIONI	DISEGNO TECNICO
	CHF 16B Sedia Taormina con braccioli impilabile	Base 55 Altezza 85 Profondità 58	
	CHF 82 Sedia Augusta con braccioli impilabile	Base 57 Altezza 82 Profondità 60	
	CHF 83 Sedia Licata impilabile microforata	Base 59 Altezza 79 Profondità 61	
	CC 47B Sedia Spaghetti in ferro con braccioli impilabile telaio bianco e filo bianco	Base 83 Altezza 78 Profondità 60	









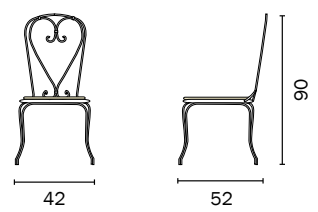

CS 44 Cuscino sedia Taormina e Augusta

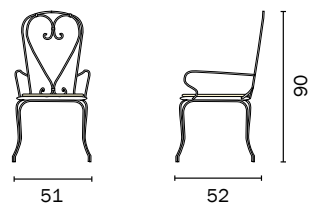
CS 83 Cuscino sedia Licata

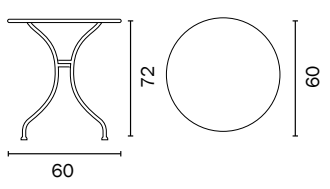
MOBILI IN FERRO COLOR BIANCO

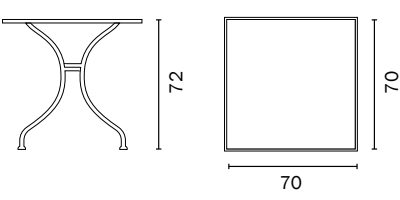
ARTICOLO	DESCRIZIONE	DIMENSIONI	DISEGNO TECNICO
 STF 31	Tavolo Messina 70 x 70 cm	Base 70 Altezza 72 Profondità 70	
 RTF 20	Tavolo Messina 140 x 80 cm	Base 140 Altezza 73 Profondità 80	

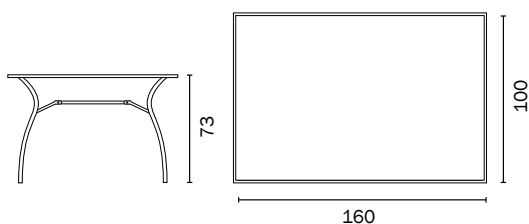
MOBILI IN FERRO COLOR AVORIO

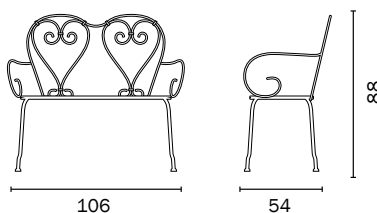
ARTICOLO	DESCRIZIONE	DIMENSIONI	DISEGNO TECNICO
	CHF 80 Sedia Sirmione impilabile senza braccioli Cuscino ecrù (Art. CS 14) venduto separatamente	Base 42 Altezza 90 Profondità 52	
	CHF 81 Sedia Sirmione con braccioli impilabile Cuscino ecrù (Art. CS 14) venduto separatamente	Base 51 Altezza 90 Profondità 52	
	TTF 82 Tavolo Peschiera	Base Ø 60 Altezza 72	
	STF 21A Tavolo Bardolino	Base 70 Altezza 72 Profondità 70	
	RTF 84 Tavolo Desenzano	Base 160 Altezza 73 Profondità 100	
	BEF 85 Panca Sirmione Cuscino ecrù (Art. CS 85) venduto separatamente	Base 106 Altezza 88 Profondità 54	

CS 14 Cuscino sedia Sirmione
CS 85 Cuscino panca Sirmione



Greenwood[®]